

**ROPES FOR
OIL & GAS APPLICATIONS**





Next generation steel wire ropes for oil & gas applications	02
Usha Martin Group	03
Oil and gas wire rope application selector	04
OCEANMAX 35	06
OCEANMAX 10S.....	09
OCEANMAX 10	10
OCEANMAX 8.....	12
OCEANMAX 6.....	14
OCEANMAX 6D	16
OCEANMAX 6RT.....	16
Preface about rope use	17
General rope characteristics	18
Strength and breaking force.....	19
Material and surface finishing.....	20
Lubrication	21
Rope behaviour under load	22
Rope rotation and torque	23
Bending fatigue	24
Factors affecting bending fatigue.....	25
Rope storage and handling.....	26
Rope installation and training.....	27
Rope winding over sheaves	28
Contact pressure between reeving components.....	29
Rope terminations	30
Typical rope damage	31
References	32

NEXT GENERATION STEEL WIRE ROPES FOR OIL & GAS APPLICATIONS



With decades of experience in manufacturing special ropes, Brunton Shaw has undertaken a major expansion program to develop the next generation of steel ropes for oil & gas applications under a new brand name.



These ropes are designed and manufactured to the very strict technical specifications demanded by our customers for today's challenging conditions.

Our highly competent and customer focused team works in close co-operation with customers to bring highly innovative solutions to the most challenging problems faced in heavy lift and other oil & gas applications.

As part of the world renowned Usha Martin Group, Brunton Shaw benefits from the continuous investment in new technology, state of the art manufacturing plant and new product development that is required to meet the exacting demands of the oil & gas industry as it tackles more hostile conditions and deeper waters.



Usha Martin is one of the largest manufacturers of high quality wire ropes in the world. For more than 50 years, the group has been dedicated to excellence and has implemented stringent process controls at each step of the manufacturing process.

The Usha Martin Group, with its own coal and iron ore mines, 150 MW power plant and over 1 million tons of speciality steel manufacturing capacity, is a truly vertically integrated business. It has a global base of steel wire rope manufacturing facilities located in India, the UK, Thailand and Dubai with service centres spread over all of the key markets in Europe, Asia, Americas and Africa.

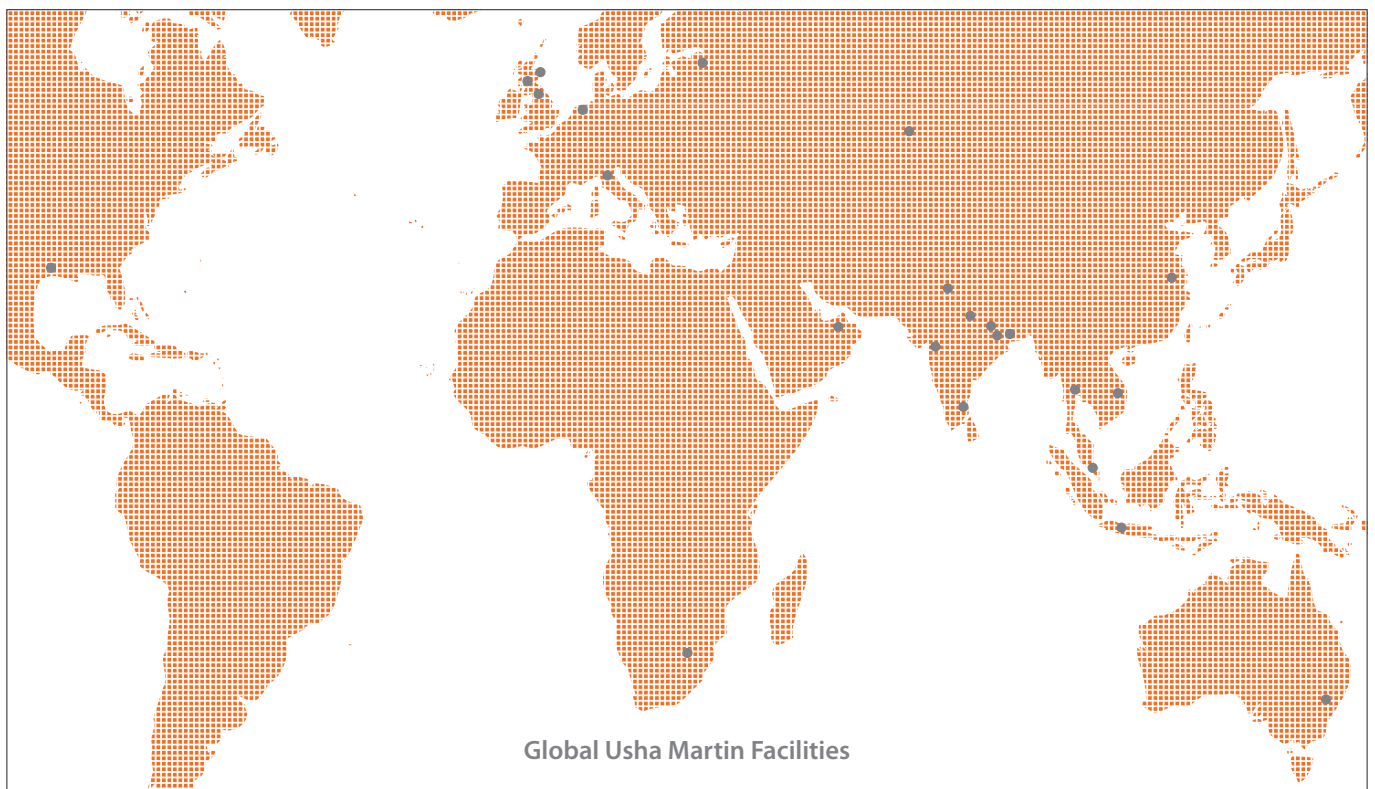

In this world without boundaries, Usha Martin is truly committed to preserve this legacy of quality all over the world and continues to harness its global presence to deliver the best possible solutions for its customers.

OIL & GAS WIRE ROPE APPLICATION SELECTOR

Key

-  Recommended
-  Allowed
-  Not recommended

	Mast Crane		Pedestal Crane		Lattice Boom Crane		Knuckle Boom Crane	
	Boom	Hoist	Boom	Hoist	Boom	Hoist		
OCEANMAX 35	✗	✓	✗	✓	✗	✓		✓
OCEANMAX 10S	✗	!	✗	!	✗	!		✗
OCEANMAX 10	✓	!	✓	!	✓	!		✗
OCEANMAX 8	✓	!	✓	!	✓	!		✗
OCEANMAX 6	✓	!	✓	!	✓	!		✗
OCEANMAX 6D	✗	✗	✗	✗	✗	✗		✗
OCEANMAX 6RT	✗	✗	✗	✗	✗	✗		✗

Rope Properties

	Fill Factor (f)	MBF Factor (k)	Mass Factor (k _m) in air	Mass Factor (k _m) in water	E. Modulus (E)*[kN/mm ²]	Torque Factor (t)*		Reference Lay Factor (K _L)*	deg./lay (R)*	
						Lang	Reg		Lang	Reg
OCEANMAX 35 style A	0.715	0.86 - 1.00	0.0049	0.0042	127	0.02	0.01	7	2	0.5
OCEANMAX 35 style B	0.725	0.86 - 1.00	0.0049	0.0042	127	0.012	0.007	7	1	0
OCEANMAX 35 style C	0.725	0.83 - 0.86	0.0049	0.0042	127	0.007	0.001	7	0.5	0
OCEANMAX 10S	0.695	0.81 - 0.95	0.0047	0.0040	125	0.055	0.045	6.5	14	4
OCEANMAX 10	0.695	0.82 - 0.96	0.0047	0.0040	127	0.125	0.090	6.5	120	70
OCEANMAX 8	0.680	0.80 - 0.95	0.0046	0.0039	125	0.11	0.085	6.5	100	60
OCEANMAX 6	0.670	0.79 - 0.92	0.0045	0.0038	122	0.11	0.078	6.5	90	60
OCEANMAX 6D	0.670	0.78 - 0.84	0.0045	0.0038	122	0.11	0.078	6.5	90	60
OCEANMAX 6RT	0.670	0.75 - 0.79	0.0045	0.0038	122	0.11	0.078	6.5	90	60

Note: nominal values @ 20% MBF for trained rope.

A&R - Traction Winch	Linear Winch	Tugger Winch	Riser Tensioner	Drilling Line
✓	✓	✓	✗	✗
!	!	✗	✗	✗
!	!	✗	✗	✗
!	!	✗	✗	✗
!	!	!	✗	✗
✗	✗	✗	✗	✓
✗	✗	✗	✓	✗

Rope Calculator

$$MBF [kN] = K \cdot d^2 \quad (d = \text{nominal diameter [mm]})$$

$$\text{Mass [kg/m]} = K_m \cdot d^2$$

$$\text{Metallic area (A) [mm}^2] = 0.785 \cdot f \cdot d^2$$

$$\text{Axial stiffness (EA) [MN]} = E \cdot 0.785 \cdot f \cdot d^2 / 1000$$

$$\text{Elastic elongation } \left[\frac{\Delta l}{l} \right] = \text{Load [kN]} / (EA \cdot 1000)$$

$$\text{Rope torque [Nm]} = t \cdot d \cdot \text{load [kN]}$$

Rope Length Available on the Reel

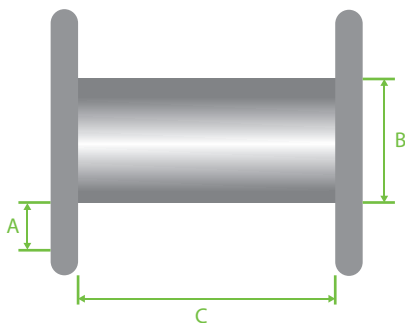

$$L = \frac{\pi \cdot A \cdot C}{d^2} \cdot (A+B)$$

A, B, C [m]
L [m]
d [mm]

Maximum Lifting Height for Block Stability

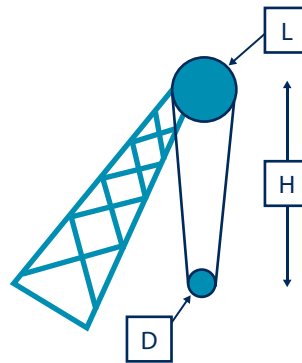

$$H = L \cdot D / (4 \cdot d \cdot t)$$

Approximate calculation in case of number of falls higher than 2

$$H = L \cdot M / (4 \cdot d \cdot t)$$

$$\text{where } M = \sqrt{B^2 + D^2}$$

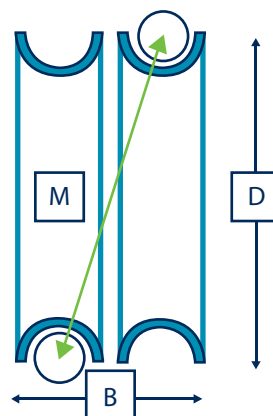



Nominal Diameter		Mass				Minimum Breaking			
Metric	Imperial	Metric		Imperial		Force		Load	
		Air	Water	Air	Water	1960	2160	1960	2160
mm	Inches	kg/m	kg/m	lb/ft	lb/ft	kN	kN	Tonnes	Tonnes
26	1	3.16	2.69	2.13	1.81	600	645	61.2	65.7
		3.31	2.82	2.23	1.90	629	676	64.1	68.9
		3.84	3.27	2.59	2.20	729	784	74.3	79.9
30	1 1/8	4.00	3.40	2.69	2.29	759	817	77.4	83.3
	1 1/4	4.41	3.75	2.97	2.52	837	900	85.3	91.7
		4.94	4.20	3.33	2.83	937	1010	95.5	103
32		5.02	4.26	3.38	2.87	952	1020	97.0	104
34		5.66	4.81	3.81	3.24	1080	1160	110	118
35		5.98	5.08	4.02	3.42	1130	1220	115	124
36	1 1/2	6.35	5.40	4.28	3.63	1210	1300	123	133
38		7.08	6.01	4.76	4.05	1340	1440	137	147
40		7.84	6.66	5.28	4.49	1490	1590	152	162
41	1 5/8	8.35	7.10	5.62	4.78	1580	1670	161	170
42		8.64	7.35	5.82	4.95	1640	1730	167	176
44		9.49	8.06	6.39	5.43	1800	1900	183	194
46	1 7/8	9.68	8.23	6.52	5.54	1840	1920	188	196
	1 3/4	10.4	8.81	6.98	5.93	1970	2050	201	209
48		11.3	9.60	7.60	6.46	2140	2230	218	227
50	2	12.3	10.4	8.25	7.01	2330	2400	238	245
		12.6	10.7	8.51	7.24	2400	2480	245	253
52	2 1/8	13.2	11.3	8.92	7.58	2510	2570	256	262
54		14.3	12.1	9.62	8.18	2710	2770	276	282
56		15.4	13.1	10.3	8.79	2920	2980	298	304
58	2 1/4	16.5	14.0	11.1	9.43	3130	3200	319	326

These figures are for guidance only. Other features, such as MBF, dimensions, lay type and plastic fill can be designed on request.

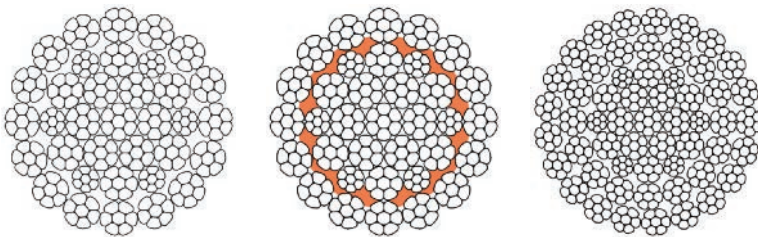

- Top class MBF to weight ratio.
- Excellent diameter stability and radial stiffness.
- Extended fatigue life and no ageing phenomenon.
- Excellent corrosion resistance.



Nominal Diameter		Mass				Minimum Breaking			
Metric	Imperial	Metric		Imperial		Force		Load	
		Air	Water	Air	Water	1770	1960	1770	1960
mm	Inches	kg/m	kg/m	lb/ft	lb/ft	kN	kN	Tonnes	Tonnes
60	2 3/8	17.8	15.2	12.0	10.2	3130	3380	319	345
62		18.8	16.0	12.7	10.8	3310	3570	337	364
64	2 1/2	20.1	17.1	13.5	11.5	3520	3810	359	388
66		21.3	18.1	14.4	12.2	3750	4050	382	413
	2 3/8	21.8	18.5	14.7	12.5	3820	4130	389	421
68		22.7	19.3	15.3	13.0	3980	4300	406	439
70	2 3/4	24.0	20.4	16.2	13.7	4210	4560	429	465
72		25.4	21.6	17.1	14.5	4460	4820	455	491
73	2 7/8	26.1	22.2	17.6	15.0	4590	4960	468	506
74		26.8	22.8	18.1	15.4	4710	5090	480	519
76		28.3	24.1	19.1	16.2	4970	5370	507	547
	3	28.5	24.2	19.2	16.3	4990	5400	509	550
77		29.1	24.7	19.6	16.6	5100	5510	520	562
80	3 1/8	31.4	26.7	21.1	17.9	5500	5950	561	607
82	3 1/4	33.4	28.4	22.5	19.1	5860	6270	597	639
84		34.6	29.4	23.3	19.8	6070	6490	619	662
86	3 3/8	36.2	30.8	24.4	20.7	6360	6800	648	693
88		37.9	32.3	25.5	21.7	6600	7050	679	719
90	3 1/2	39.7	33.7	26.7	22.7	6970	7290	710	743
92	3 5/8	41.5	35.3	28.0	23.8	7290	7630	743	778
94		43.3	36.8	29.2	24.8	7600	7860	775	801
95	3 3/4	44.5	37.8	29.9	25.4	7800	7980	795	813
96		45.2	38.4	30.4	25.8	7930	8110	808	827
98	3 7/8	47.5	40.3	32.0	27.2	8330	8430	849	859
100		49.0	41.7	33.0	28.0	8600	8700	877	887

These figures are for guidance only. Other features, such as MBF, dimensions, lay type and plastic fill can be designed on request.





Nominal Diameter		Mass				Minimum Breaking			
Metric	Imperial	Metric		Imperial		Force		Load	
		Air	Water	Air	Water	1770	1960	1770	1960
mm	Inches	kg/m	kg/m	lb/ft	lb/ft	kN	kN	Tonnes	Tonnes
102	4	51.0	43.3	34.3	29.2	8950	9050	912	923
104		53.0	45.0	35.7	30.3	9300	9410	948	959
105	4 1/8	54.0	45.9	36.4	30.9	9480	9590	966	978
106		55.1	46.8	37.1	31.5	9660	9780	985	997
108	4 1/4	57.2	48.6	38.5	32.7	10000		1020	
109		58.2	49.5	39.2	33.3	10200		1040	
110		59.3	50.4	39.9	33.9	10300		1050	
112	4 3/8	61.5	52.5	41.4	35.2	10700		1090	
114	4 1/2	64.0	54.4	43.1	36.6	11100		1130	
115		64.8	55.1	43.6	37.1	11200		1140	
117	4 5/8	67.6	57.5	45.5	38.7	11700		1190	
119		69.4	59.0	46.7	39.7	12000		1220	
120	4 3/4	71.3	60.6	48.0	40.8	12400		1260	
122		72.9	62.0	49.1	41.7	12500		1270	
124	4 7/8	75.3	64.0	50.7	43.1	12900		1310	
125		76.6	65.1	51.5	43.8	13100		1340	
126		77.8	66.1	52.4	44.5	13300		1360	
127	5	79.0	67.2	53.2	45.2	13500		1380	
128		80.3	68.2	54.1	45.9	13800		1410	
130	5 1/8	83.0	70.6	55.9	47.5	14100		1440	
132		85.4	72.6	57.5	48.9	14500		1480	
134	5 1/4	88.0	74.8	59.2	50.4	14900		1520	
135		89.3	75.9	60.1	51.1	15100		1540	
136	5 3/8	91.3	77.6	61.5	52.3	15500		1580	
138		93.3	79.3	62.8	53.4	15800		1610	
139		94.7	80.5	63.7	54.2	16000		1630	
140	5 1/2	96.0	81.6	64.7	55.0	16300		1660	
142	5 5/8	100	85.0	67.3	57.2	16900		1720	
144		102	86.4	68.4	58.1	17200		1750	
146	5 3/4	105	88.8	70.4	59.8	17700		1800	
148		107	91.2	72.3	61.4	18200		1860	
150	5 7/8	110	93.7	74.2	63.1	18700		1910	
152	6	114	96.7	76.6	65.1	19300		1970	
154		116	98.8	78.2	66.5	19700		2010	
156	6 1/8	119	101	80.3	68.2	20200		2060	
158	6 1/4	123	105	83.1	70.7	20900		2130	
160		125	107	84.5	71.8	21200		2160	

These figures are for guidance only. Other features, such as MBF, dimensions and lay type can be designed on request.





Nominal Diameter		Mass				Minimum Breaking			
Metric	Imperial	Metric		Imperial		Force		Load	
		Air	Water	Air	Water	1960	2160	1960	2160
mm	Inches	kg/m	kg/m	lb/ft	lb/ft	kN	kN	Tonnes	Tonnes
26	1	3.03	2.58	2.04	1.74	561	613	57.2	62.5
		3.18	2.70	2.14	1.82	588	642	59.9	65.4
		3.68	3.13	2.48	2.11	682	745	69.5	75.9
30	1 ¼	3.84	3.26	2.58	2.20	710	776	72.4	79.1
	1 ½	4.23	3.60	2.85	2.42	783	855	79.8	87.2
		4.74	4.03	3.19	2.71	877	958	89.4	97.7
32	1 ¾	4.81	4.09	3.24	2.75	891	973	90.8	99.2
34		5.43	4.62	3.66	3.11	1010	1100	103	112
35		5.73	4.87	3.86	3.28	1060	1160	108	118
36	1 ⅝	6.09	5.18	4.10	3.49	1130	1230	115	125
38		6.79	5.77	4.57	3.88	1260	1370	128	140
40		7.52	6.39	5.06	4.30	1390	1520	142	155
41	1 ¾	8.01	6.81	5.39	4.58	1480	1600	151	163
42		8.29	7.05	5.58	4.74	1530	1660	156	169
44		9.10	7.73	6.13	5.21	1680	1820	171	186
46	1 ¾	9.29	7.89	6.25	5.31	1720	1860	175	190
	1 ⅝	9.95	8.45	6.70	5.69	1840	1990	188	203
48		10.8	9.20	7.29	6.20	2000	2140	204	218
50	2	11.8	10.0	7.91	6.72	2180	2330	222	238
52		12.1	10.3	8.17	6.94	2250	2400	229	245
		12.7	10.8	8.56	7.27	2350	2510	240	256
54	2 ¼	13.7	11.6	9.23	7.84	2540	2710	259	276
56	2 ½	14.7	12.5	9.92	8.44	2730	2920	278	298
58		15.8	13.4	10.6	9.02	2930	3090	299	315
60	2 ⅝	17.1	14.5	11.5	9.79	3170	3350	323	341

These figures are for guidance only. Other features, such as MBF, dimensions, lay type and plastic fill can be designed on request.

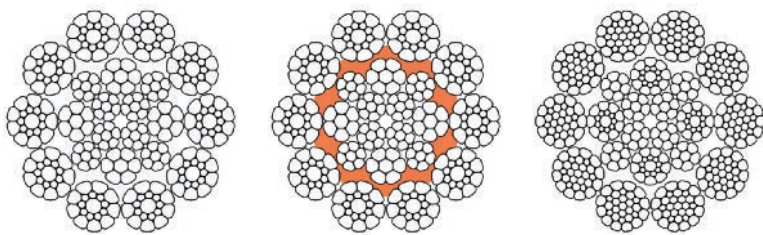

- Lower torque factor in respect to traditional hoist ropes.
- High radial stiffness.
- Excellent resistance to side pressure and crushing.
- Enhanced resistance to fleet angles if plastic impregnated.



Nominal Diameter		Mass				Minimum Breaking			
Metric	Imperial	Metric		Imperial		Force		Load	
		Air	Water	Air	Water	1960	2160	1960	2160
mm	Inches	kg/m	kg/m	lb/ft	lb/ft	kN	kN	Tonnes	Tonnes
26	1	3.03	2.58	2.04	1.74	568	619	57.9	63.1
		3.18	2.70	2.14	1.82	595	649	60.7	66.2
		3.68	3.13	2.48	2.11	690	753	70.3	76.8
30	1 1/8	3.84	3.26	2.58	2.20	719	784	73.3	79.9
	1 1/4	4.23	3.60	2.85	2.42	792	864	80.7	88.1
		4.74	4.03	3.19	2.71	887	968	90.4	98.7
32		4.81	4.09	3.24	2.75	901	983	91.8	100
34		5.43	4.62	3.66	3.11	1020	1110	104	113
35		5.73	4.87	3.86	3.28	1070	1170	109	119
36	1 1/2	6.09	5.18	4.10	3.49	1140	1240	116	126
38		6.79	5.77	4.57	3.88	1270	1390	129	142
40		7.52	6.39	5.06	4.30	1410	1540	144	157
41	1 5/8	8.01	6.81	5.39	4.58	1500	1620	153	165
42		8.29	7.05	5.58	4.74	1550	1680	158	171
44		9.10	7.73	6.13	5.21	1700	1840	173	188
46	1 3/4	9.29	7.89	6.25	5.31	1740	1880	177	192
	1 7/8	9.95	8.45	6.70	5.69	1860	2010	190	205
48		10.8	9.20	7.29	6.20	2030	2170	207	221
50	2	11.8	10.0	7.91	6.72	2200	2350	224	240
		12.1	10.3	8.17	6.94	2270	2430	231	248
52	2 1/8	12.7	10.8	8.56	7.27	2380	2540	243	259
54		13.7	11.6	9.23	7.84	2570	2740	262	279
56		14.7	12.5	9.92	8.44	2760	2950	281	301
58	2 1/4	15.8	13.4	10.6	9.05	2960	3130	302	319
60	2 3/8	17.1	14.5	11.5	9.79	3200	3380	326	345

These figures are for guidance only. Other features, such as MBF, dimensions, lay type and plastic fill can be designed on request.

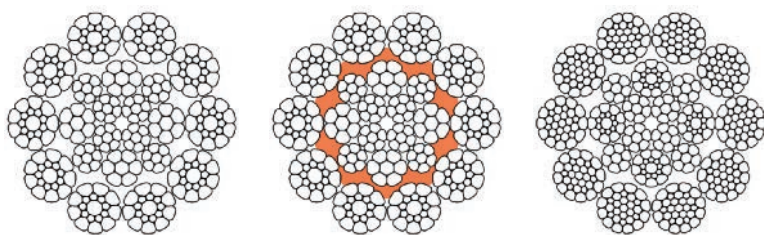

- Lower torque factor in respect to traditional hoist ropes.
- High radial stiffness.
- Excellent resistance to side pressure and crushing.
- Enhanced resistance to fleet angles if plastic impregnated.



Nominal Diameter		Mass				Minimum Breaking			
Metric	Imperial	Metric		Imperial		Force		Load	
		Air	Water	Air	Water	1770	1960	1770	1960
mm	Inches	kg/m	kg/m	lb/ft	lb/ft	kN	kN	Tonnes	Tonnes
62		18.1	15.4	12.2	10.3	3150	3570	321	364
64	2 ½	19.3	16.4	13.0	11.0	3360	3810	343	388
66		20.5	17.4	13.8	11.7	3570	4050	364	413
	2 ¾	20.9	17.8	14.1	12.0	3650	4130	372	421
68		21.7	18.5	14.6	12.4	3790	4300	386	438
70	2 ¾	23.0	19.6	15.5	13.2	4020	4560	410	465
72		24.4	20.7	16.4	13.9	4250	4770	433	486
73	2 ¾	25.1	21.3	16.9	14.3	4370	4910	445	501
74		25.7	21.9	17.3	14.7	4490	5040	458	514
76		27.1	23.1	18.3	15.5	4740	5310	483	541
	3	27.3	23.2	18.4	15.6	4760	5340	485	544
77		27.9	23.7	18.8	15.9	4860	5450	495	556
80	3 ¼	30.1	25.6	20.3	17.2	5250	5890	535	600
82	3 ¼	32.0	27.2	21.6	18.3	5590	6270	570	639
84		33.2	28.2	22.3	19.0	5790	6490	590	662
86	3 ¾	34.8	29.5	23.4	19.9	6060	6800	618	693
88		36.4	30.9	24.5	20.8	6350	7050	647	719
90	3 ½	38.1	32.4	25.6	21.8	6640	7370	677	751
92	3 ¾	39.8	33.9	26.8	22.8	6950	7710	708	786
94		41.5	35.3	28.0	23.8	7250	8040	739	820
95	3 ¾	42.6	36.2	28.7	24.4	7440	8170	758	833
96		43.3	36.8	29.2	24.8	7560	8290	771	845
98	3 ¾	45.5	38.7	30.7	26.1	7940	8620	809	879
100		47.0	40.0	31.6	26.9	8200	8900	836	907
102	4	48.9	41.6	32.9	28.0	8530	9260	870	944
104		50.8	43.2	34.2	29.1	8870	9410	904	959
105	4 ¼	51.8	44.0	34.9	29.7	9040	9590	922	978
106		52.8	44.9	35.6	30.2	9210	9780	939	997
108	4 ¼	54.8	46.6	36.9	31.4	9560	10000	975	1020
109		55.8	47.5	37.6	32.0	9740	10200	993	1040
110		56.9	48.3	38.3	32.5	9920	10400	1010	1060
112	4 ¾	59.0	50.1	39.7	33.7	10300	10700	1050	1090
114	4 ½	61.4	52.2	41.3	35.1	10700	11000	1090	1120
115		62.2	52.8	41.8	35.6	10800	11100	1100	1130
117	4 ¾	64.9	55.1	43.7	37.1	11300	11600	1150	1180
119		66.6	56.6	44.8	38.1	11600	11900	1180	1210
120	4 ¾	68.4	58.2	46.1	39.2	11900	12100	1210	1230
122		70.0	59.5	47.1	40.0	12200	12400	1240	1260
124	4 ¾	72.3	61.4	48.7	41.4	12600	12800	1280	1300
125		73.4	62.4	49.4	42.0	12800	13000	1300	1330
126		74.6	63.4	50.2	42.7	13000		1330	
127	5	75.8	64.4	51.0	43.4	13200		1350	
128		77.0	65.5	51.8	44.1	13400		1370	
130	5 ½	79.6	67.7	53.6	45.6	13900		1420	

These figures are for guidance only. Other features, such as MBF, dimensions, lay type and plastic fill can be designed on request.



Nominal Diameter		Mass				Minimum Breaking			
Metric	Imperial	Metric		Imperial		Force		Load	
		Air	Water	Air	Water	1960	2160	1960	2160
mm	Inches	kg/m	kg/m	lb/ft	lb/ft	kN	kN	Tonnes	Tonnes
26	1	2.97	2.52	2.00	1.70	568	613	57.9	62.5
28		3.11	2.64	2.09	1.78	595	642	60.7	65.4
		3.61	3.07	2.43	2.06	690	745	70.3	75.9
30	1 1/8	3.76	3.19	2.53	2.15	719	776	73.3	79.1
		4.14	3.52	2.79	2.37	792	855	80.7	87.2
	1 1/4	4.64	3.94	3.12	2.65	887	958	90.4	97.7
32		4.71	4.00	3.17	2.70	901	973	91.8	99.2
34		5.32	4.52	3.58	3.04	1020	1100	104	112
35	1 3/8	5.61	4.77	3.78	3.21	1070	1160	109	118
36		5.96	5.07	4.01	3.41	1140	1220	116	124
38	1 1/2	6.64	5.65	4.47	3.80	1270	1360	129	139
40		7.36	6.26	4.96	4.21	1410	1500	144	153
41	1 5/8	7.84	6.66	5.28	4.48	1500	1600	153	163
42		8.11	6.90	5.46	4.64	1550	1660	158	169
44		8.91	7.57	6.00	5.10	1700	1820	173	186
46	1 7/8	9.09	7.73	6.12	5.20	1740	1860	177	190
		9.73	8.27	6.55	5.57	1860	1990	190	203
48	1 7/8	10.6	9.01	7.14	6.07	2030	2140	207	218
50		11.5	9.78	7.74	6.58	2200	2330	224	238
	2	11.9	10.1	7.99	6.79	2270	2400	231	245
52		12.4	10.6	8.37	7.12	2380	2510	243	256
54	2 1/8	13.4	11.4	9.03	7.68	2570	2710	262	276
56		14.4	12.3	9.71	8.26	2760	2890	281	295
58	2 1/4	15.5	13.2	10.4	8.86	2960	3090	302	315
60	2 1/4	16.7	14.2	11.3	9.58	3200	3350	326	341
62		17.7	15.0	11.9	10.1	3380	3540	345	361
64	2 1/2	18.8	16.0	12.7	10.8	3600	3770	367	384
66		20.0	17.0	13.5	11.5	3830	4010	390	409
	2 3/8	20.4	17.4	13.8	11.7	3910	4050	399	413
68		21.3	18.1	14.3	12.2	4070	4210	415	429
70	2 3/4	22.5	19.2	15.2	12.9	4310	4460	439	455
72		23.8	20.3	16.1	13.6	4560	4720	465	481
73	2 7/8	24.5	20.9	16.5	14.0	4690	4800	478	489
74		25.2	21.4	17.0	14.4	4820	4930	491	503
76		26.6	22.6	17.9	15.2	5080	5200	518	530
	3	26.7	22.7	18.0	15.3	5110	5230	521	533
77		27.3	23.2	18.4	15.6	5220	5280	532	538
80	3 1/8	29.4	25.0	19.8	16.8	5630	5700	574	581

These figures are for guidance only. Other features, such as MBF, dimensions, lay type and plastic fill can be designed on request.

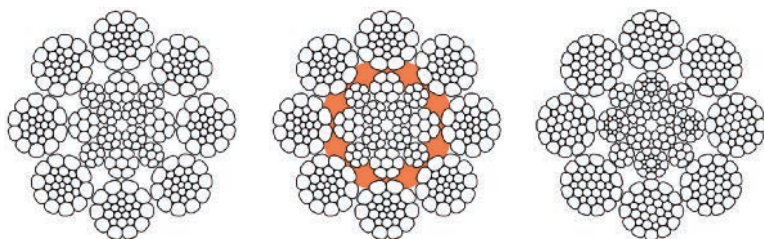

- Smoother contact surface in respect to conventional ropes.
- High resistance to side pressure and crushing.
- Enhanced resistance to fleet angles if plastic impregnated.



Nominal Diameter		Mass				Minimum Breaking			
Metric	Imperial	Metric		Imperial		Force		Load	
		Air	Water	Air	Water	1770	1960	1770	1960
mm	Inches	kg/m	kg/m	lb/ft	lb/ft	kN	kN	Tonnes	Tonnes
82	3 ¼	31.3	26.6	21.1	17.9	5520	5930	563	604
84		32.5	27.6	21.9	18.6	5720	6140	583	626
86	3 ⅝	34.0	28.9	22.9	19.5	5990	6360	611	648
88		35.6	30.3	24.0	20.4	6270	6580	639	671
90	3 ½	37.3	31.7	25.1	21.3	6560	6890	669	702
92	3 ¾	39.0	33.1	26.3	22.3	6870	7210	700	735
94		40.6	34.5	27.4	23.3	7160	7420	730	756
95	3 ¾	41.7	35.5	28.1	23.9	7350	7620	749	777
96		42.4	36.0	28.5	24.3	7460	7650	760	780
98	3 ⅞	44.6	37.9	30.0	25.5	7850	8040	800	820
100		46.0	39.1	31.0	26.3	8100	8300	826	846
102	4	47.9	40.7	32.2	27.4	8430	8530	859	870
104		49.8	42.3	33.5	28.5	8760	8870	893	904
105	4 ⅛	50.7	43.1	34.1	29.0	8930	9040	910	922
106		51.7	43.9	34.8	29.6	9100		928	
108	4 ¼	53.7	45.6	36.1	30.7	9450		963	
109		54.7	46.5	36.8	31.3	9620		981	
110		55.7	47.3	37.5	31.9	9800		999	
112	4 ⅝	57.7	49.0	38.9	33.0	10000		1020	

These figures are for guidance only. Other features, such as MBF, dimensions, lay type and plastic fill can be designed on request.





Nominal Diameter		Mass				Minimum Breaking			
Metric	Imperial	Metric		Imperial		Force		Load	
		Air	Water	Air	Water	1960	2160	1960	2160
mm	Inches	kg/m	kg/m	lb/ft	lb/ft	kN	kN	Tonnes	Tonnes
26	1	2.90	2.47	1.95	1.66	548	594	55.9	60.6
28		3.04	2.59	2.05	1.74	575	622	58.6	63.4
30		3.53	3.00	2.38	2.02	666	721	67.9	73.5
	1 1/8	3.67	3.12	2.47	2.10	694	751	70.7	76.6
		4.05	3.44	2.73	2.32	765	819	78.0	83.5
	1 1/4	4.54	3.86	3.05	2.60	857	917	87.4	93.5
32		4.61	3.92	3.10	2.64	870	932	88.7	95.0
34		5.20	4.42	3.50	2.98	983	1050	100	107
35	1 1/4	5.49	4.67	3.70	3.14	1040	1110	106	113
36		5.83	4.96	3.93	3.34	1100	1170	112	119
38	1 1/2	6.50	5.52	4.38	3.72	1230	1300	125	133
40		7.20	6.12	4.85	4.12	1360	1440	139	147
41	1 1/2	7.67	6.52	5.16	4.39	1450	1530	148	156
42		7.94	6.75	5.34	4.54	1500	1590	153	162
44		8.71	7.41	5.87	4.99	1650	1740	168	177
46	1 3/4	8.89	7.56	5.99	5.09	1680	1780	171	181
48	1 3/4	9.52	8.09	6.41	5.45	1800	1900	183	194
50		10.4	8.81	6.98	5.93	1960	2070	200	211
		11.3	9.56	7.57	6.44	2130	2250	217	229
	2	11.6	9.87	7.82	6.65	2190	2320	223	236
52		12.2	10.3	8.19	6.96	2300	2430	234	248
54	2 1/8	13.1	11.2	8.83	7.51	2480	2620	253	267
56		14.1	12.0	9.50	8.08	2670	2820	272	287
58	2 1/4	15.1	12.9	10.2	8.66	2860	3030	292	309
60	2 1/4	16.4	13.9	11.0	9.37	3090	3280	315	334
62		17.3	14.7	11.6	9.90	3270	3460	333	353
64	2 1/2	18.4	15.7	12.4	10.5	3480	3690	355	376
66		19.6	16.7	13.2	11.2	3700	3920	377	400
	2 3/4	20.0	17.0	13.5	11.4	3780	4000	385	408
68		20.8	17.7	14.0	11.9	3930	4160	401	424
70	2 3/4	22.1	18.7	14.8	12.6	4170	4410	425	450
72		23.3	19.8	15.7	13.4	4410	4670	450	476
73	2 3/4	24.0	20.4	16.2	13.7	4530	4800	462	489
74		24.6	20.9	16.6	14.1	4650	4930	474	503
76		26.0	22.1	17.5	14.9	4910	5200	501	530
	3	26.1	22.2	17.6	15.0	4940	5230	504	533
77		26.7	22.7	18.0	15.3	5040	5340	514	544
80	3 1/8	28.8	24.5	19.4	16.5	5440	5700	555	581

These figures are for guidance only. Other features, such as MBF, dimensions, lay type and plastic fill can be designed on request.

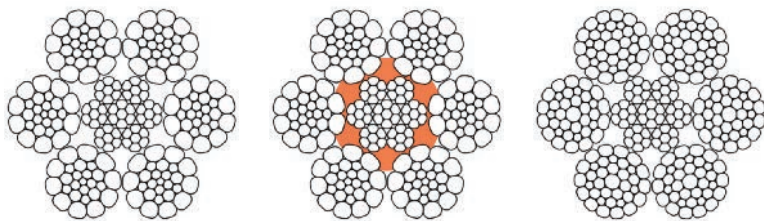

- Improved MBF in respect to conventional hoist ropes.
- Enhanced radial stiffness in respect to conventional hoist ropes.
- Good resistance to side pressure and crushing.



Nominal Diameter		Mass				Minimum Breaking			
Metric	Imperial	Metric		Imperial		Force		Load	
		Air	Water	Air	Water	1770	1960	1770	1960
mm	Inches	kg/m	kg/m	lb/ft	lb/ft	kN	kN	Tonnes	Tonnes
82	3 ¼	30.7	26.1	20.6	17.5	5380	5790	548	590
84		31.8	27.0	21.4	18.2	5570	6000	568	612
86	3 ⅜	33.3	28.3	22.4	19.0	5840	6290	595	641
88		34.8	29.6	23.5	19.9	6120	6580	624	671
90	3 ½	36.5	31.0	24.5	20.9	6400	6890	652	702
92	3 ⅝	38.2	32.4	25.7	21.8	6700	7210	683	735
94		39.8	33.8	26.8	22.8	6980	7510	712	766
95	3 ¾	40.8	34.7	27.5	23.4	7170	7710	731	786
96		41.5	35.3	27.9	23.7	7280	7830	742	798
98	3 ⅞	43.6	37.1	29.4	24.9	7650	8230	780	839
100		45.0	38.3	30.3	25.8	7900	8400	805	856
102	4	46.8	39.8	31.5	26.8	8220	8740	838	891

These figures are for guidance only. Other features, such as MBF, dimensions, lay type and plastic fill can be designed on request.



OCEANMAX 6D

DRILLING LINES



Nominal Diameter		Mass				Minimum Breaking	
Metric	Imperial	Metric		Imperial		Force	Load
		Air	Water	Air	Water	1770	1960
mm	Inches	kg/m	kg/m	lb/ft	lb/ft	kN	Tonnes
28.6	1 1/8	3.71	3.15	2.50	2.12	686	69.9
31.8	1 1/4	4.58	3.89	3.08	2.62	833	84.9
34.9	1 3/8	5.53	4.70	3.72	3.16	1000	102
38.1	1 1/2	6.58	5.59	4.43	3.77	1170	119
41.3	1 5/8	7.71	6.55	5.19	4.41	1380	141
44.5	1 7/8	8.95	7.61	6.03	5.12	1590	162
50.8	2	11.7	9.95	7.88	6.70	2010	205

These figures are for guidance only. Other features, such as MBF, dimensions, lay type and plastic fill can be designed on request.

OCEANMAX 6RT

RISER TENSIONER



Nominal Diameter		Mass				Minimum Breaking			
Metric	Imperial	Metric		Imperial		Force		Load	
		Air	Water	Air	Water	1770 dual	IPS/1770	1770 dual	IPS/1770
mm	Inches	kg/m	kg/m	lb/ft	lb/ft	kN	kN	Tonnes	Tonnes
44		8.71	7.41	5.87	4.99	1450	1530	148	156
	1 3/4	8.89	7.56	5.99	5.09	1480	1560	151	159
48	1 7/8	10.4	8.81	6.98	5.93	1730	1820	176	186
	2	11.6	9.87	7.82	6.65	1940	2040	198	208
52		12.2	10.3	8.19	6.96	2030	2140	207	218
54	2 1/8	13.1	11.2	8.83	7.51	2190	2300	223	234
56		14.1	12.0	9.50	8.08	2350	2480	240	253
58	2 1/4	15.1	12.9	10.2	8.66	2520	2660	257	271
60	2 3/8	16.4	13.9	11.0	9.37	2730	2870	278	293
64	2 1/2	18.4	15.7	12.4	10.5	3070	3240	313	330
	2 5/8	20.0	17.0	13.5	11.4	3330	3510	339	358
70	2 3/4	22.1	18.7	14.8	12.6	3680	3870	375	394
73	2 7/8	24.0	20.4	16.2	13.7	4000	4210	408	429
76		26.0	22.1	17.5	14.9	4330	4560	441	465

These figures are for guidance only. Other features, such as MBF, dimensions, lay type and plastic fill can be designed on request.

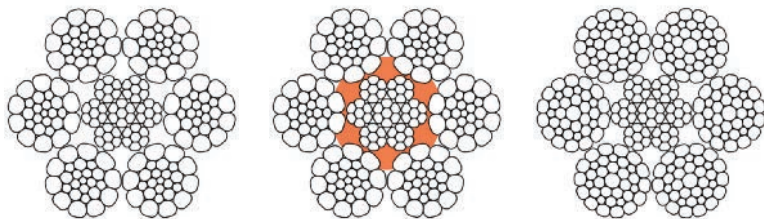

- Compliant to international standards.
- High fatigue resistance.
- High dimensional stability.
- Enhanced sheave imprinting resistance if dual strength.



A wire rope can be described in simple terms as an assembly of several strands laid helically in different possible arrangements, in order to bear axial loads. To be fit for purpose, it must also meet other criteria, such as resistance to side loads, flexibility, handling and stability.

This definition, however, does not fully reflect the increasingly challenging requirements of wire rope design, manufacture, use and inspection for the oil and gas sector. Ropes for these applications make an essential contribution to efficiency and reliability, and of course, the fundamental consideration for any rope in any application is safety compliance.

To ensure high quality standards, our company has developed a comprehensive design and manufacturing process, which includes custom design software, state of the art manufacturing equipment and skilled personnel with proven expertise.

The content of this catalogue is a brief abstract of wire rope characteristics and recommendations for use in the oil and gas industry.

Our highly skilled technical team are available to provide support for specific customer requirements, and welcome the opportunity to work together to provide solutions for any complex technical issues.

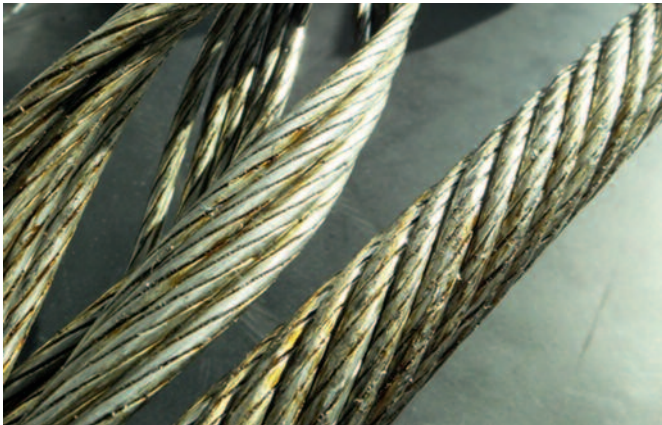

Definitions

Strand:	An element of rope consisting of an assembly of wires of appropriate shape and dimensions laid helically in the same direction in one or more layers around a centre.
Stranded rope:	An assembly of several strands laid helically in one or more layers around a core (single-layer rope) or centre (rotation-resistant or parallel-closed rope).
Rope class:	A grouping of ropes of similar mechanical properties and physical characteristics.
Rope construction:	The detail and arrangement of the various elements of the rope.
Minimum breaking force:	Specified value in kN, below which the measured breaking force is not allowed to fall in a prescribed breaking force test and normally obtained by calculation from the product of the square of the nominal diameter, the rope grade and the breaking force factor
ABF/ABL:	Actual Breaking Force. Actual Breaking Force is commonly referred to as Actual Breaking Load (ABL). These two terms mean the same thing. The force (load) required to cause a wire rope to fail by fracture or distorting to such an extent that the load is released. This is not to be confused with aggregate breaking force, which is the sum of the breaking forces of the wires composing the rope.

GENERAL ROPE CHARACTERISTICS



Each rope is first of all characterized by its nominal diameter, from which the actual diameter is estimated depending on regulations, application type and specific customer requests.

The actual diameter of wire rope changes during use due to initial rope stabilization, the effect of working tension, and wear caused by passage over components of the reeving system.

To ensure good rope performance when operating on grooved drums, the actual diameter has to comply with the oversize of the groove. Typical diameter tolerance is +2% / +4%. This value is very common for heavy lifting applications, and will be the reference value for the information contained in this catalogue, however it can be adapted on the basis of specific customer requirements.

Lay direction is selected to confer peculiar characteristics to the product: when spooled over drums, Lang's lay ropes ensure better stability to side wear (a phenomenon also known as "crushing") as the contacts between the wires of rope wraps are smoother than in regular lay construction. On the other hand, regular lay improves rotation stability and is therefore recommended for ropes having a diameter greater than 40mm, used for high lifting heights or deployment into deep sea situations.

Lay length is also selected in accordance with specific requirements: longer lay improves load capacity, Young modulus and consequently axial stiffness, whereas shorter lay gives better resistance to shock loading.

Ropes for heavy lifting activities require a high load efficiency and are typically composed of compacted strands, obtained by means of dies or roller devices during manufacture.

High compacting level allows an improvement in the metallic area of up to 15% with respect to conventional strands, and also leads to smoother surface contact, dimensional stability in respect to side pressure, resistance to wear and abrasion, and better spooling capacity.

In case of reeving arrangements involving a relatively high fleet angle between adjacent components (from 2° to 4°), plastic impregnated core ropes can be adopted to enhance rope stability.

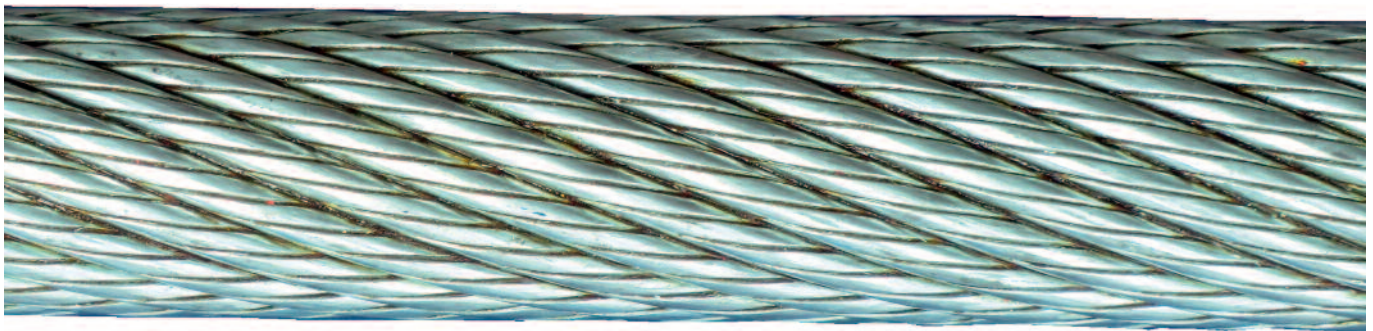

Definitions

Lay direction:	The direction right (Z or RH) or left (S or LH) corresponding to the direction of lay of the outer strands in a stranded rope in relation to the longitudinal axis of the rope.
Ordinary lay (or regular):	Stranded rope in which the direction of lay of the wires in the outer strands is in the opposite direction to the lay of the outer strands in the rope (RL).
Lang lay:	Stranded rope in which the lay direction of the wires in the outer strands is in the same lay direction as that of the outer strands in the rope (LL).
Rope lay length (H):	That distance (H) parallel to the longitudinal rope axis in which the outer wires of a spiral rope, the outer strands of a stranded rope or the unit ropes of a cable-laid rope make one complete turn (or helix) about the axis of the rope.



A fundamental requirement for wire rope is achievement of the minimum breaking force that complies with the crane or winch safe working load.

Rope breaking force can be seen as a function of metallic area, strength and spinning factor. These elements must be carefully combined to confer reliable mechanical properties.

Metallic area depends on the rope's geometrical construction, diameter oversize and compacting level; strength is dependent on the characteristics of the wire; and spinning factor is dependent on manufacturing skill, geometrical construction and compacting level.

However, it must be emphasised that a high breaking force in itself is not sufficient to ensure safe working conditions.

For a wire rope to be considered safe, it must be possible to assess, within an acceptable timescale, that it is approaching the end of its service life or if the prescribed payload has been exceeded.

Good quality ropes must be composed of ductile wires, which will break gradually following remarkable plastic deformation. This gradual breakage will be clearly noticeable by a competent person with responsibility for rope integrity management.

Ropes that rely solely on the use of extremely high strength wires for their breaking force can have severe implications in terms of safety, as the wires will have the tendency to break suddenly without giving proper notice of arising problems.

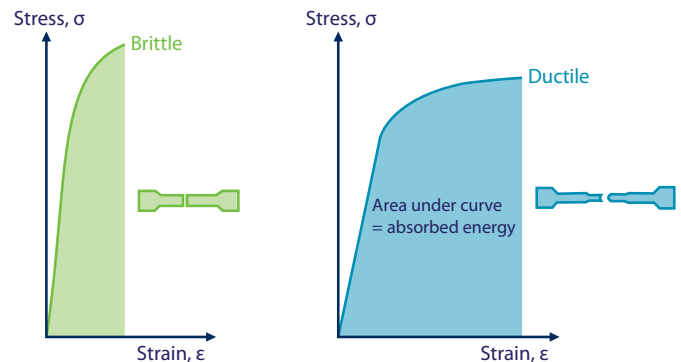

The graph above compares the behaviour of wires with different strengths: the green line represents a brittle trend typical of high strength steel (over 2160 N/mm²). The blue line represents the typical trend of lower strength steel (1770 and 1960 N/mm²).

It is therefore essential to adopt the minimum possible strength level and to achieve the desired breaking force by a combination of high compacting level, finely tuned geometrical construction and manufacturing reliability.

Definitions

- Metallic cross-section (A):** The product of the nominal metallic cross-sectional area factor (C) and the square of the nominal rope diameter.
- Fill factor (f):** The ratio between the sum of the nominal metallic cross-sectional areas of all the wires in the rope and the circumscribed area of the rope based on its nominal diameter (d).
- Rope grade:** A level of requirement of breaking force which is designated by a number (e.g. 1770, 1960). NOTE - it does not imply that the actual tensile strength grades of the wires in the rope are necessarily of this grade.
- Wire tensile strength grade:** A level of requirement of tensile strength of a wire and its corresponding range. It is designated by the value according to the lower limit of tensile strength and is used when specifying wire and when determining the calculated minimum breaking force or calculated minimum aggregate breaking force of a rope, expressed in N/mm².
- Tensile strength:** The ratio between the maximum force obtained in a tensile test and the nominal cross-sectional area of the test piece, expressed in N/mm².



Correct selection of raw material is essential in order to achieve the required breaking force and mechanical characteristics.

Our wire ropes are manufactured using a high carbon content, patented rod, which allows both wire strength and ductility to be achieved, without the adoption of extreme rope grades.

The rod is subjected to a drawing process, which consists of a number of passages through a series of tungsten carbide dies with a gradual diameter reduction. During this process, the metallurgical structure of the rod changes from a very thin perlite pattern to well aligned fibres with high tenacity and strength.

The combination of carbon content and amount of drawing is determined depending on the specific application of the wire rope and the required mechanical characteristics.

Steel has to be protected against corrosion and consequently bright ropes, which are still popular for some applications, have a very limited use in oil and gas applications, while zinc coating is highly recommended for the marine environment.

The quantity of zinc which has to be applied to wires is regulated by EN10264-2 – Steel wire and wire products – Non ferrous metallic coatings on steel wire – Zinc or zinc alloy coatings.

For rope used within the oil and gas industry, the typical zinc thickness is approximately 20 to 25 microns, which complies with class B.



Zinc is applied by a hot dip process in order to avoid hydrogen embrittlement typical of electrochemical plating. Hot dip galvanizing creates a tight connection between zinc and steel, virtually alloying them in one unique entity.

For severe environmental conditions, improved surface finishing based on zinc aluminium alloys can also be adopted.

It must be emphasised that surface finishing has to be adopted in conjunction with adequate lubrication and maintenance levels in order to preserve wire rope performance.

Definitions

Finish and quality of coating: The condition of the surface finish of the wire e.g. uncoated (bright), zinc coated, zinc alloy coated or other protective coating and the class of coating, e.g. class B zinc coating, defined by the minimum mass of coating and the adherence of the coating to the steel below.

Mass of coating: The mass of coating (obtained by a prescribed method) per unit of surface area of the uncoated wire, expressed in g/m².

Proper lubrication is essential to maintain rope performance in use, protect it against corrosion and preserve its service life.

Good quality lubricants are characterized by high adherence to steel in order to withstand passage over the reeving system, light colouring which will not obstruct the detection of possible rope damage and high compatibility with other products, which is particularly important for vessels operating globally.

Drop point has to be high enough to tolerate rope storage and operation in warm environments but with a safety borderline that is sufficient to detect rope overheating during the use of special devices such as heave compensators.

Since steel can suffer permanent deterioration if subjected to high temperatures for extended periods, a good temperature limitation and consequent drop point is approximately 80°C.

Lubricant can be applied during different manufacturing phases: stranding, core closing and final closing.

When applied during stranding, the lubricant is firmly engaged within the rope structure and reduces friction between the wires. If applied during core closing it creates a barrier against external elements penetration and if applied during final closing it further increases protection against corrosion.

The quantity of lubricant applied during rope manufacture has to be carefully evaluated on the basis of rope usage and working environment. If insufficient lubricant is applied, the rope will not be adequately protected, however, an excess of lubricant may be squeezed out of the rope during installation and use, thereby

creating environmental and safety issues. This particularly applies to boom hoist ropes operating on offshore vessels, which run over reeving systems composed of a high number of sheaves.

The most suitable levels of manufacturing lubrication are shown in the figure below.

The first image refers to very small size ropes, with lubrication applied only during stranding.

The second figure refers to ropes for industrial lifting, with lubrication applied during stranding and core closing.

The third figure refers to ropes for marine environment applications, with lubrication also applied during final closing operations. This is the most frequent option for oil and gas applications.

The fourth image shows a very high amount of lubricant, required for ropes operating subsea or dealing with very severe environmental conditions.

Before rope installation and during rope use, the lubrication level must be periodically inspected to detect any overall or localised faults and, where required, relubrication can be performed by using appropriate pressure devices.

For ropes operating subsea, lubricant should be applied during deployment in order to fill the strands gaps and prevent water penetration and trapping.

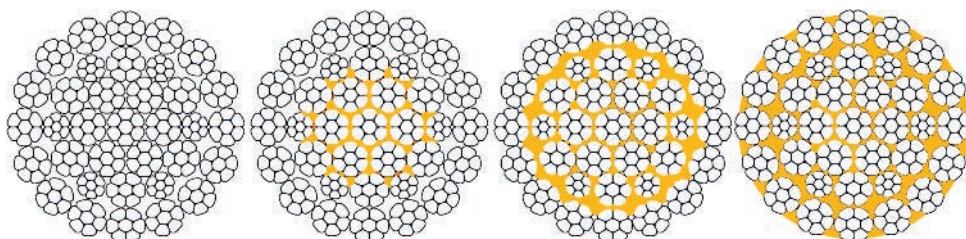

Definitions

Rope lubricant:

A material applied during the manufacture of a strand, core or rope for the purpose of reducing internal friction and/or assisting in providing protection against corrosion.

ROPE BEHAVIOUR UNDER LOAD



When a rope is subjected to axial loads, the elasticity of the material will cause elongation and consequential diameter reduction.

This behaviour is summarized in the first figure, which shows the relationship between stress (the ratio between applied load and metallic area) and strain (ratio between elongation and initial sample length), while the slope of the curve represents Young modulus "E".

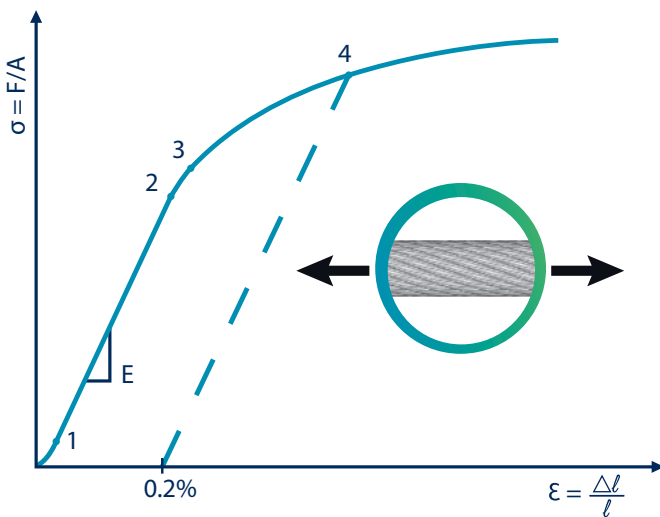

In the first phase of its use (up to point 1), rope shows a certain permanent stretch due to the stabilization of the individual wires. After this step, the trend is basically linear up to the achievement of yield point (points 3 and 4), from which point permanent plastic deformation takes place, until the load reaches the actual rope breaking force.

As already mentioned in the section "Strength & Breaking Force", a good rope composed of ductile wires must have a long elastic area to ensure safe working conditions.

Rope diameter shows a permanent reduction after the first utilization cycles; the trend is shown in the second figure.

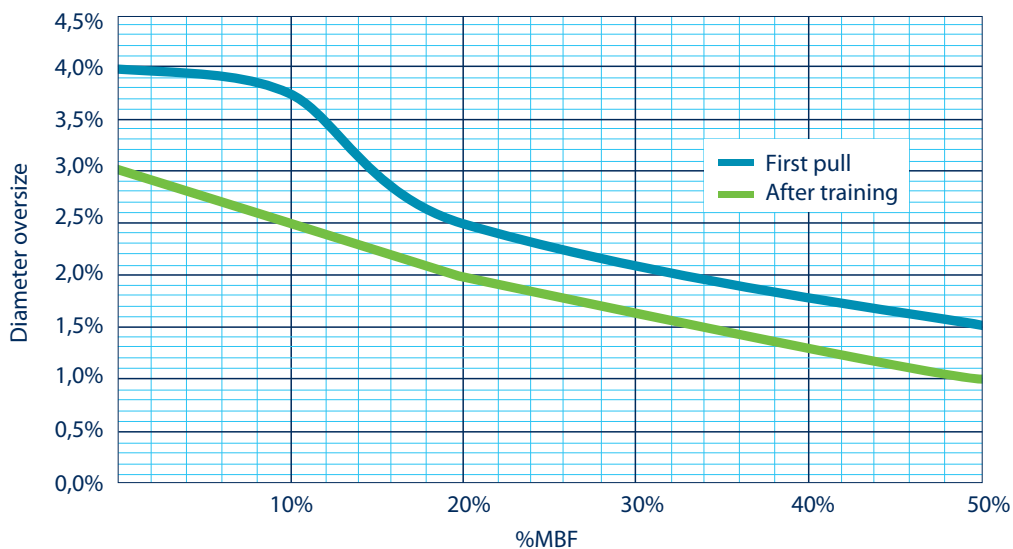

ROPE ROTATION AND TORQUE



Being composed of several helically laid components with elastic characteristics, each wire rope has the tendency to turn when subjected to load. This tendency is represented by rope torque factor, which is dependent on rope construction, previous working conditions and applied load.

In a similar way, rope will also oppose forced rotation, depending on its rotational stiffness.

Ropes can be classified on the basis of torque factor, as spin resistant, low rotation or rotation resistant.

Since torque factor depends primarily on rope construction, this has to be selected on the basis of the reeving structure and lifting or deployment height, in order to ensure block and load stability.

Non rotating ropes are strongly recommended for high lifting heights in single fall mode, while for multiple fall other constructions can be considered depending on block configuration.

During the first use of rope wound over a drum, the portion of wire rope coming out from the winch will start to rotate depending on rope construction and applied load.

When the rope is rewound over the drum, the rotation obtained during deployment will be stored into the winch: therefore, if the rope is used to deploy the same load at the same height, no additional rotation will take place.

If the rope conditions are not the same, different behaviour will occur.

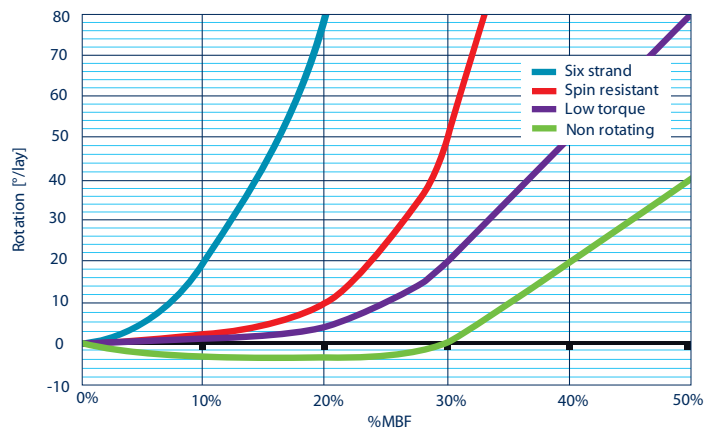
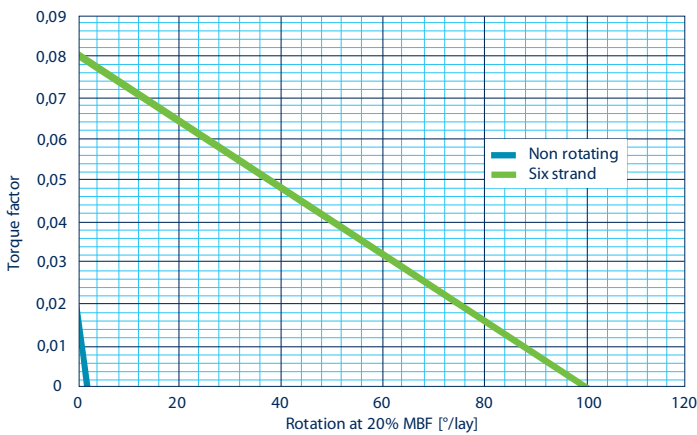

Definitions

Rope torque: Torsional characteristic, the value of which is usually expressed in Nm, at a stated tensile loading and determined by test when both rope ends are prevented from rotating. NOTE: Torsional characteristics can also be determined by calculation.

Rope turn: Rotational characteristic, the value of which is usually expressed in degrees or turns per unit length at a stated tensile loading and determined by test when one end of the rope is free to rotate.



Fatigue damage is a typical phenomenon which is not caused by a single event, but by repeated bending, tension and rotational stresses: since the working life of wire ropes generally involves repeated passages over drum and sheaves, this damage has to be carefully considered during operations.

The first factor to be considered with respect to fatigue damage is the working load: taking a safety factor of five as a reference point, relative service life of rope operating in the same system with different loads is shown in the first figure.

Fatigue damage occurs gradually, and becomes evident when it reaches a point where it has caused a high number of broken

wires and consequent wire elongation, which rapidly increase to reach wire rope discard criteria.

The typical trend of fatigue growth is shown in the second graph: it is clear that there is a rapid increase in the curve slope after a certain threshold, and this is strongly affected by working load.

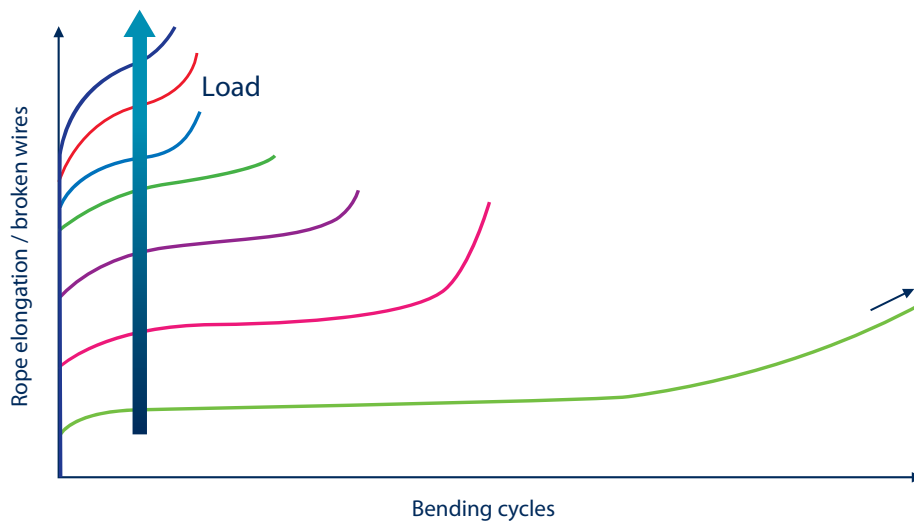
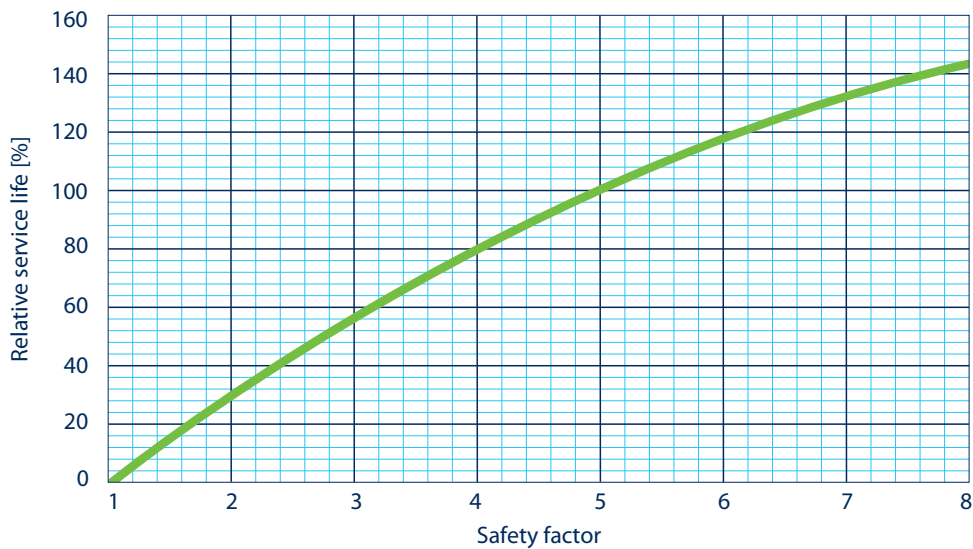

Definitions

Fatigue: Progressive and localized damage due to cyclic stress.

FACTORS AFFECTING BENDING FATIGUE



Since fatigue is an inherent phenomenon, it cannot be eliminated, however it can be slowed down by adopting, when possible, particular features with respect to rope design and system layout.

With respect to rope design, the most effective way to reduce fatigue evolution is by avoiding the use of extremely high strength wires (over 2160 kN/mm²). As already mentioned, this improves steel ductility allowing a better resistance to repeated bending cycles.

Contrary to expectation, rope composed of many small wires may not have higher fatigue resistance, especially when working at low safety factor. In terms of system design, there are several strategies that can be adopted to preserve rope life.

The first tool is to increase the bending ratio of the component over which the rope is running. This can have some practical limitations, especially when dealing with large size ropes, however it has to be emphasised that the typical recommended ratio for good fatigue performance is approximately 20.

Another approach which can be adopted without major expense is the selection of proper groove size. The recommended value is approximately 1.08 times the nominal rope diameter, depending on rope type and possible fleet angle.

Fleet angle must be always considered and limited, as it creates a stress within the structure of the rope and contributes to fatigue build up: it should not exceed 2°, or 4° for ropes having plastic impregnated cores.

In case of fleet angle, groove oversize should be increased to 1.10 or more in order to facilitate the passage of the rope through the groove.

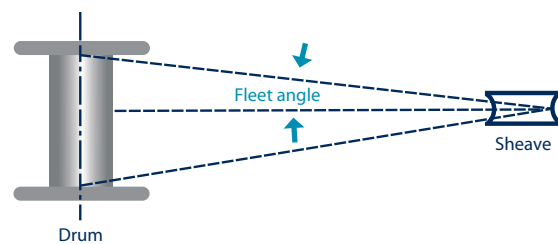
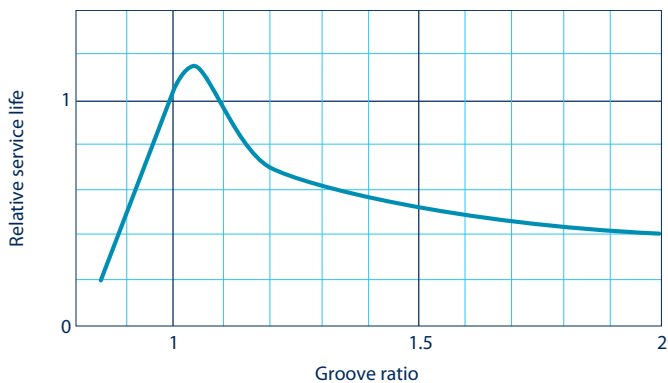
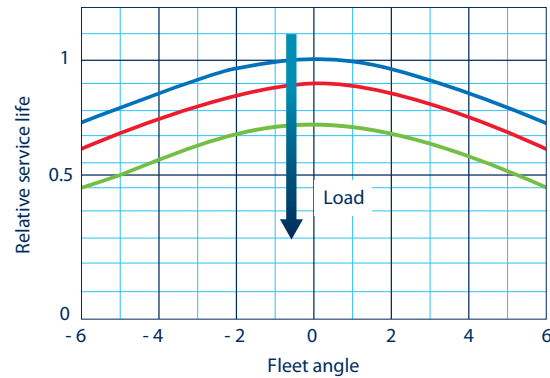
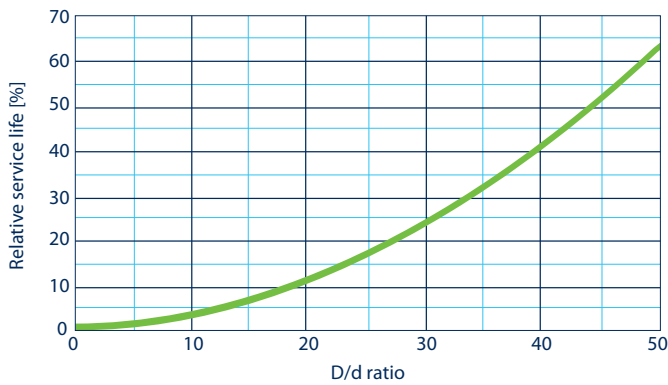

ROPE STORAGE & HANDLING



Storage of the rope in very warm or humid conditions should be avoided as this could break down the effectiveness of native lubrication and accelerate the deterioration process.

Wire ropes are lubricated during manufacture in accordance with application type and customer specification. This lubrication will be long-lasting if the rope is properly stored.

Lubrication condition should be verified on a regular basis and before rope installation, to detect possible grease anomalies. In case of doubt, rope should be cleaned from surface contaminants and properly relubricated.

In order to ensure maximum performance during operations, rope for special applications, including oil and gas, are not fully

performed during manufacturing, therefore proper serving is essential to avoid unlaying and safety issues.

Rope integrity management should be undertaken by properly trained personnel, with reference to applicable codes, standards and regulations for handling and inspection requirements.

Below is an example of safety label currently adopted by wire rope manufacturers.

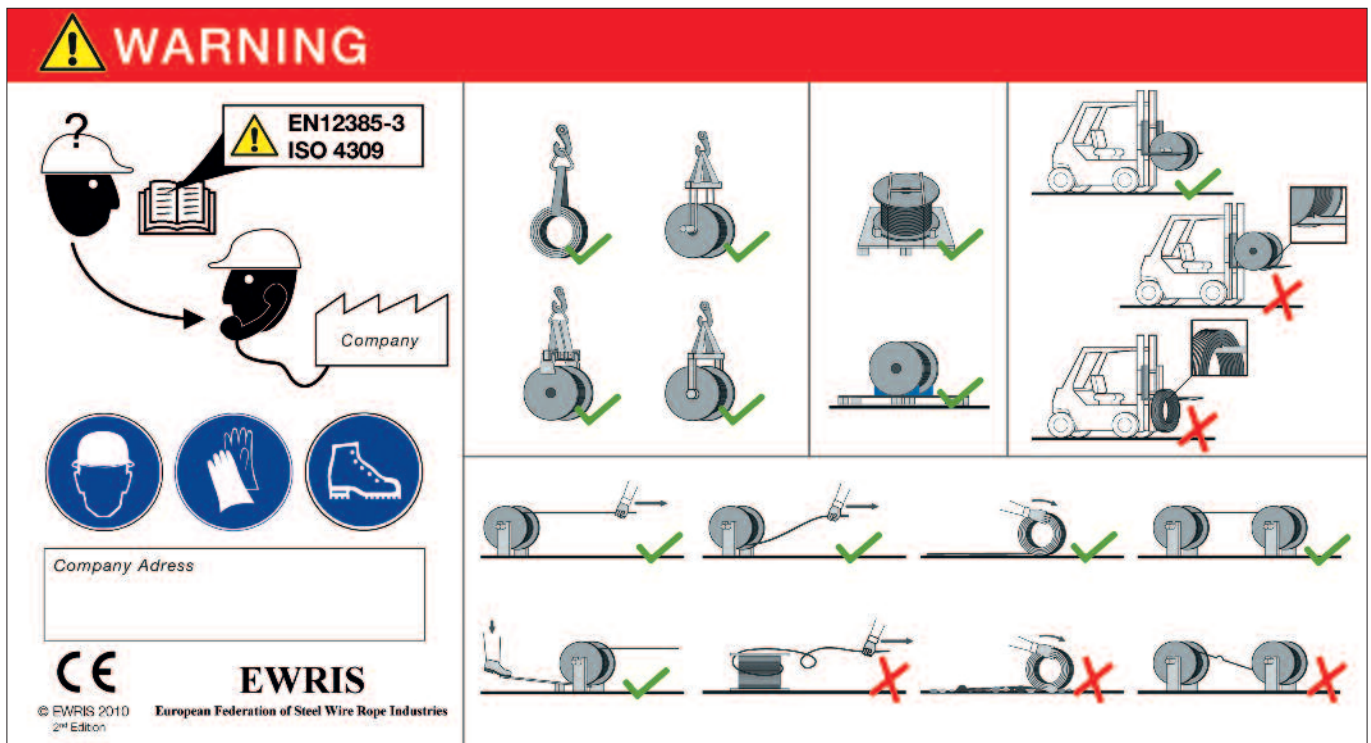

Definitions

- Fully performed rope:** Rope in which the wires in the strands and strands in the rope have their internal stresses reduced, resulting in a rope in which, after removal of any serving, the wires and the strands will not spring out of the rope formation.
- Serving:** Wrapping, usually made of wire or strand, for the purpose of securing a rope end to prevent its unlaying.
- Permanent serving:** Serving applied prior to socketing and remaining in place at least until the socketing operation has been completed.
- Temporary serving:** Serving applied and subsequently removed at various stages of the socketing operation.
- Competent person:** Designated person, suitably trained, qualified by knowledge and experience and with the necessary instructions to ensure that the required operations are correctly carried out.



Unless otherwise agreed with the customer, ropes are provided on reels which are designed for the purpose of transportation and storage. They can therefore bear a limited amount of pulling tension when unwinding the rope.

The direction of rope lay should be chosen in accordance to drum direction following the general rule “right hand pitch – left hand rope”, see image below. However this is often not applicable to heavy lifting devices, which usually requires the use of large size multilayer drums.

In this case, there are no special requirements and lay direction can be selected to facilitate the drum bedding, or optimized taking into account the rope layer that will be more frequently used during operations.

In order to ensure expected lifespan and performance, it is essential to have a tight bedding on the first winch drum layer, which is achieved by applying the correct installation tension. It should be at least the highest value between 2% of the rope MBF or 10% of rope SWL.

This tension can be easily achieved with commonly available tools for relatively small size ropes.

In the case of large size rope a good practice could be to wind the rope using the maximum available back tension and obtain the correct value during the training stage.

Training is essential for any rope size to optimize rope lifetime and performance, as well as to stabilize its dimensions.

It involves the deployment of the full rope length, excluding the safety wraps, which must always remain on the drum, at least three times with any available payload: the weight of the rope will automatically generate the required back tension, diameter stabilization and torque factor reduction.

Safety wraps should be clearly identified to prevent unnoticed use.

A good spooling will show tight wraps and uniform rope arrangement in the cross over zone and up the last layers. This will reduce the risk of crushing, cut-in or early formation of broken wires.

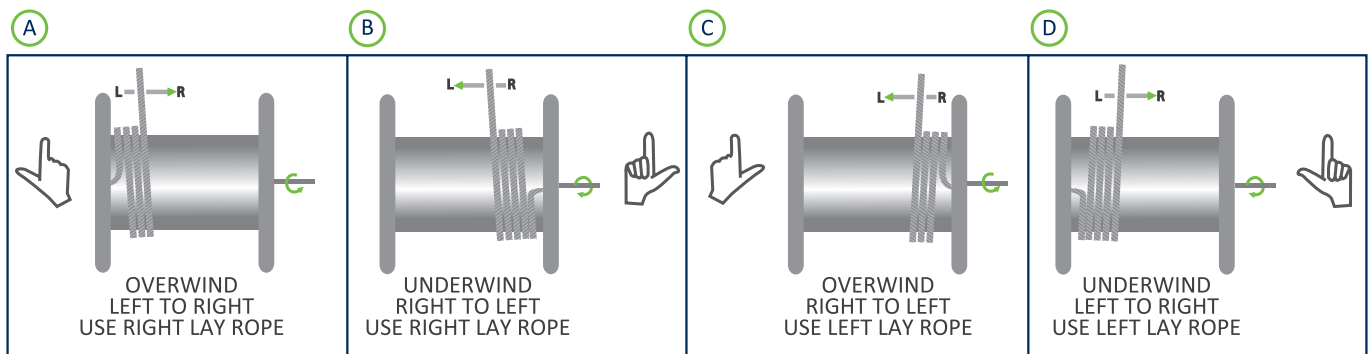

Definitions

WLL/SWL:	Working Load Limit/Safe Working Load. WLL is the ultimate permissible load, assigned by the manufacturer of the item (crane). The SWL may be the same as the WLL but may be a lower value assigned by an independent competent person taking account of particular service conditions.
Working length:	Working length is the portion of total length plus three wraps that has been used in operations since the last thorough examination.
Wraps/layers:	A wrap is a single turn of a wire rope around the circumference of a drum. A layer is a number of wraps covering the horizontal distance between the drum flanges.
Cross-over zone:	That portion of rope coincident with a crossing over of one wrap by another as the rope traverses the drum or rises from one layer to the next at the drum flange.

ROPE WINDING OVER SHEAVES



When a rope runs over the reeving, its strands are forced to modify their relative position to maintain contact with the system. If the reeving arrangement is not properly designed, the strands cannot recover their natural location in the passage between adjacent components, therefore the rope can suffer premature fatigue or localized damage.

This particularly applies in case of reverse bending configuration, where the strands are stretched and compressed between two sheaves (see sketch below). To avoid permanent damage, for complete reverse bending (see left sketch) the minimum recommended distance is about 100 times the rope diameter.

For partial reverse bending (see right sketch), a lower distance could be accepted.

Both in the case of reverse and simple bending, the sheaves have to be properly designed in terms of size, groove configuration and hardness.

As already mentioned, the minimum recommended bending ratio is 20 times the rope nominal diameter, while the recommended groove oversize can vary from 1.06 to 1.1 times the rope diameter.

In order to allow a smooth contact surface, the rope should be in touch with the sheave for at least 1.5 times its lay length, which corresponds approximately to a 60° winding angle for a sheave having a bending ratio of 20. For very small winding values the stress induced to the rope is not very relevant, while in the intermediate range, from 10° 45°, significant damage can occur, especially if the component is located in the high tension side of the reeving.

This figure does not apply in case of rollers or sheaves with reduced bending ratio (up to 10), since the rope has to deal with a relatively small bending ratio. In this case, it is always recommended to adopt a minimum bending ratio equal to the winding angle (e.g. 2 D/d minimum in case of 2° winding angle).

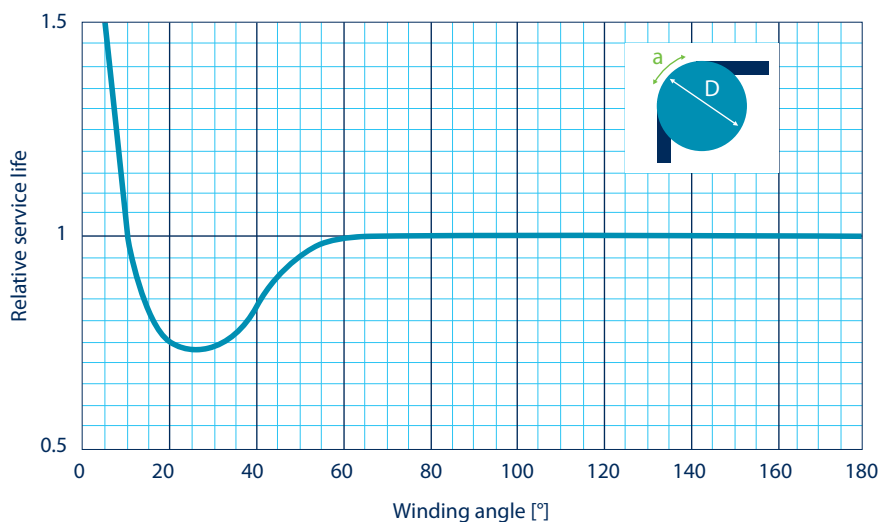
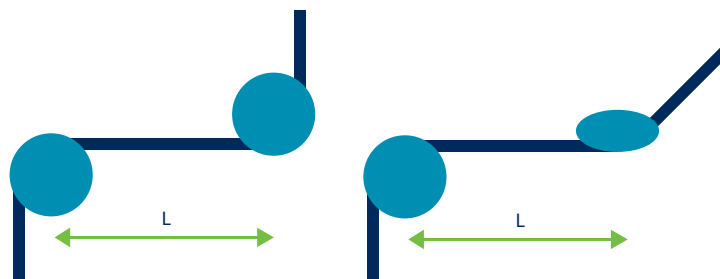

CONTACT PRESSURE BETWEEN REEVING COMPONENTS



When the rope is bent over a component, it generates pressure which is dependent on its diameter, the diameter of the component over which the rope is bent and the applied tension.

The nominal average pressure can be calculate using the following formula:

$$\text{Pressure, } P = \frac{2T}{Dd}$$

P = pressure [N/mm²]

T = rope tension [N]

D = diameter of sheave or drum [mm]

d = diameter of rope [mm]

Multistrand and non rotating ropes ensure a better pressure distribution than six strand ropes, as the higher number of outer strands generates a wider contact surface (see figures below).

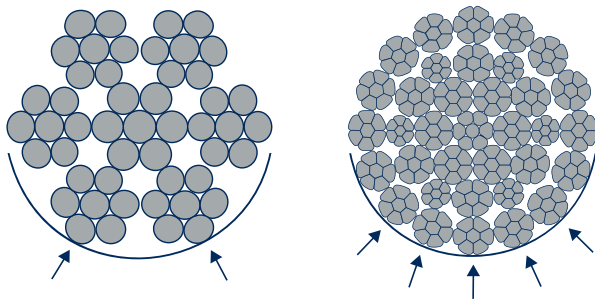

Compacted strands and Lang's lay ropes further extend the contact surface.

In order to ensure proper performance, the groove material should ensure a smooth and hard contact: in case of inadequate hardness, the steel will be locally hardened, with consequent embrittlement and detachment of steel flakes, which can damage both the rope and the component itself. The typical recommendation is to use hardened steel with approximate 300 HB value.

In case of synthetic sheaves, the yield point of the material should be higher than the exerted pressure, calculated using the formula above.

A good groove dimension is also important to achieve a reduced pressure. The diagram below shows different configurations depending on various groove oversize: narrow, well dimensioned and large groove.

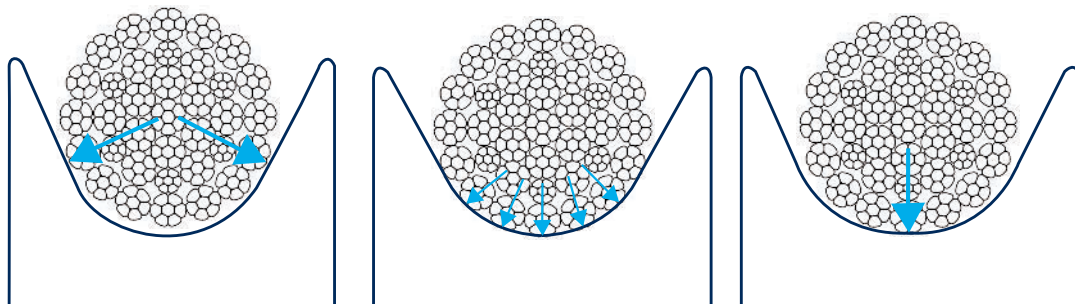

ROPE TERMINATIONS







Temporary end connections must be used only for rewinding or installation, while permanent end connections can also be used for actual operations.

Permanent connections allow the Safe Working Load to be maintained and are characterized by a specific efficiency depending on the connection type, which varies from 100% for resin sockets to 80% for wedge sockets.

Temporary end connections must not be used as lifting devices, as they are not designed to ensure Safe Working Load but only to allow the rope to be moved from the storage reel to another reel or to the winch drum.

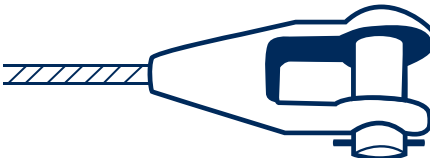
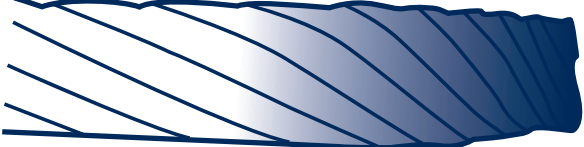
During lifting, swivels can be used for non rotating ropes in case of special crane applications but must be avoided where rotation resistant ropes are not used, as they will have the tendency to unlay under load.

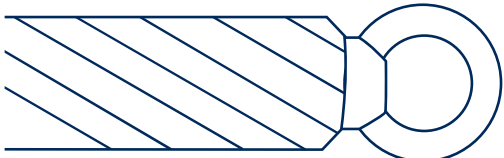
Some examples of end connections are shown in the following table. Special sockets or connections can be provided on demand.

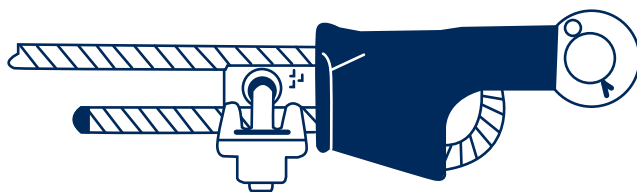
Temporary	Permanent
<p>Becket loop</p> 	<p>Open spelter socket</p> 
<p>Tapered</p> 	<p>Closed spelter socket</p> 
<p>Bolted eye</p> 	<p>Cylindrical socket</p> 
<p>Chinese finger - Cable sock</p> 	<p>Wedge socket</p> 

TYPICAL ROPE DAMAGE

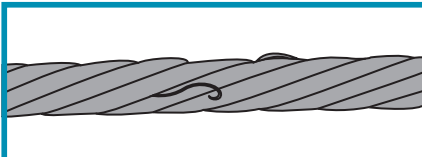
Wire protrusion

Cause Improper rope handling
Ref. ISO4309 - 6.6.5
Action Discard (can be removed for limited extension)

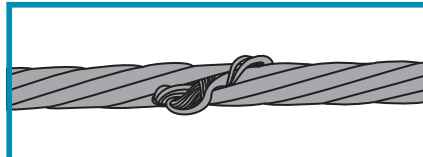

Core protrusion

Cause Fleet angle, shock loading
Ref. ISO4309 - 6.6.4
Action Immediate discard

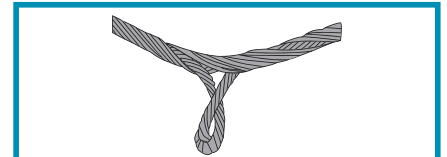

Protrusion of inner rope

Cause Fleet angle, shock loading
Ref. ISO4309 - E.4 c)
Action Immediate discard

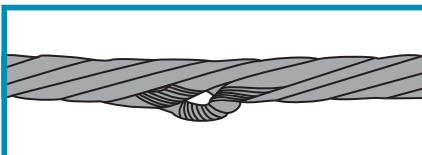

Strand protrusion or distortion

Cause Forced twist
Ref. ISO4309 - 6.6.4
Action Immediate discard

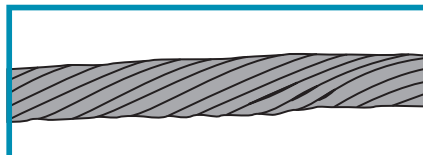

Local increase in rope diameter

Cause Fleet angle
Ref. ISO4309 - 6.6.6
Action Remove the cause and monitor the evolution

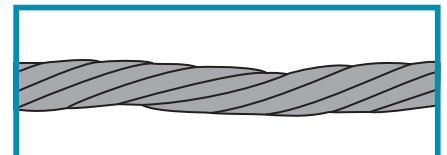

Local reduction in diameter

Cause Core break
Ref. ISO4309 - 6.3
Action Immediate discard

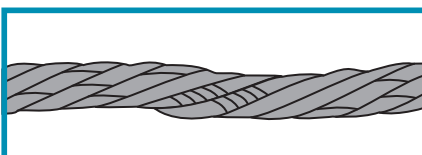

Kink (positive)

Cause Fleet angle, forced rotation
Ref. ISO4309 - 6.6.8
Action Immediate discard

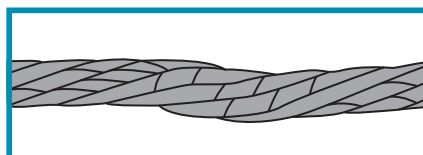

Kink (negative)

Cause Fleet angle, forced rotation
Ref. ISO4309 - 6.6.8
Action Immediate discard

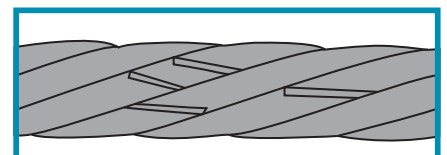

Valley wire breaks

Cause Fatigue and improper rope design
Ref. ISO4309 - 6.2
Action Discard (can be removed for limited extension)

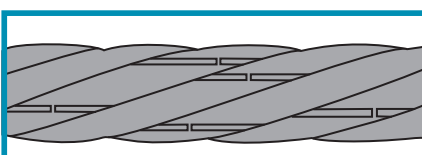

Crown wire breaks

Cause Fatigue
Ref. ISO4309 - 6.2
Action Discard (can be removed for limited extension)

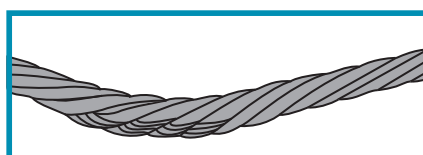

Flattened portion

Cause Rope derailing over the sheave
Ref. ISO4309 - 6.6.7
Action Immediate discard

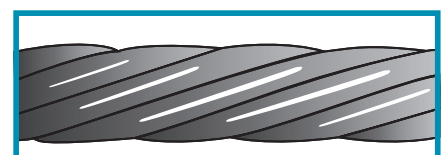

External wear

Cause Normal use
Ref. ISO4309 - 5.3.1, E2
Action Keep monitored

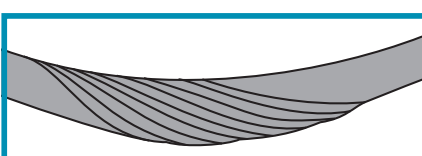

Basket deformation (birdcage)

Cause Improper installation, narrow grooves
Ref. ISO4309 - 6.6.3
Action Immediate discard

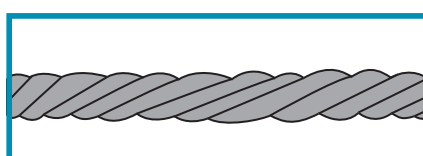

Waviness

Cause Reverse bending, rope rotation
Ref. ISO4309 - 6.6.2
Action Keep monitored



External corrosion

Cause Environment conditions
Ref. ISO4309 - 6.5
Action Keep monitored

Listed actions are for general purpose only, please contact technical services for specific recommendations.



The following list includes the main reference documents for marine, offshore and subsea wire ropes. The list is not exhaustive, as there may be additional customer standards, local legislation and internal guidance to be considered.

All the definitions included in this catalogue are based on the listed documents.

- EN 12385-1:2009 – Steel wire ropes – Safety Part 1: General requirements
- EN 12385-2:2008 – Steel wire ropes – Safety Part 2: Definitions, designation and classification
- EN 12385-3:2008 – Steel wire ropes – Safety Part 3: Information for use and maintenance
- EN 12385-4:2008 – Steel wire ropes – Safety Part 4: Stranded ropes for general lifting applications
- EN 13411-3:2011 – Terminations for steel wire ropes – Safety Part 3: ferrules and ferrule-securing
- EN 13411-4:2011 – Terminations for steel wire ropes – Safety Part 4: metal and resin socketing
- EN 13411-5:2011 – Terminations for steel wire ropes – Safety Part 5: U-bolt wire rope grips
- EN 13411-6:2011 – Terminations for steel wire ropes – Safety Part 6: Asymmetric wedge socket
- EN 13411-7:2011 – Terminations for steel wire ropes – Safety Part 7: Symmetric wedge socket
- EN10244-2 – Steel wire and wire products – Non ferrous metallic coatings on steel wire – Zinc or zinc alloy coatings
- EN 10264-1:2002 – Steel wire and wire products – Steel wire for ropes – General requirements
- EN 10264-2:2002 – Steel wire and wire products – Steel wire for ropes – Cold drawn non-alloyed steel wire for ropes for general applications
- EN12927– Part 8 – Magnetic rope testing
- ISO 17558:2006 – Steel wire ropes – Socketing procedures – Molten metal and resin socketing
- ISO 4309:2010 – Cranes – Wire ropes – Care and maintenance, inspection and discard
- IMCA M171 – Crane specification document
- IMCA M179 – Guidance on the use of cable laid slings and grommets
- IMCA M187 – Guidelines for lifting operations
- IMCA M194 – Wire rope integrity management for vessels in the offshore industry
- IMCA M197 – Guidance on non-destructive examination (NDE) by means of magnetic rope testing
- API 9A/ISO 10425:2003 – Steel wire ropes for the petroleum and natural gas industries – Minimum requirements and terms of acceptance
- API RP 9B:2005 – American Petroleum Institute recommended practice for application, care and use of wire rope for oilfield services
- Wire rope technical board – Wire rope user’s manual 4th edition
- ASTM E 1571 – 06 – American Society for Testing of Materials – Standard practice for electromagnetic examination of ferromagnetic steel wire ropes
- Klaus Feyrer – Wire ropes – Tension, Endurance, Reliability

Conversion factors

1	metric t (tonne)	=	0.672	lbs/ft
1	m	=	3.28	ft
1	mm	=	0.039	inch
1	kg	=	2.205	lbs
1	lb	=	0.0005	short t (ton)
1	metric t (tonne)	=	1.10	short t (ton)
1	metric t (tonne)	=	0.984	long t
1	kN	=	0.102	metric tf
1	N/mm ² (Mpa)	=	145	psi

1	lbs/ft	=	1.49	kg/m
1	ft	=	0.305	m
1	inch	=	25.4	mm
1	lbs	=	0.454	kg
1	short t (ton)	=	2000	lb
1	short t (ton)	=	0.907	metric t (tonne)
1	long t	=	1.016	metric t (tonne)
1	metric tf	=	9.81	kN
1	psi	=	0.0069	N/mm ² (Mpa)

SALES

Usha Martin Limited
2a Shakespeare Sarani
700071 Kolkata
India
Tel +91 33 3980 0300

Usha Martin Americas Inc.
701 Plastics Avenue
TX 77020
Houston
USA
Tel +1 713 676 1800

De Ruiter Staalkabel b.v.
Ringerstraat 7
3364 BA, Sliedrecht
Holland
Tel +31 184 499999

Usha Martin Singapore Pte Ltd
91 Tuas Bay Drive
637307
Singapore
Tel +65 6265 7756

Global Design Centre

Usha Martin Italia srl
Via Nikolajewka 1
25062 Concesio (BS)
Italy

European Management & Marine Corp.

Howe Moss Place
AB21 0GS
Scotland
Tel +44 1224 775151

Usha Martin China Co Ltd.

No. 122 East Fu Te No. 1 Rd.
China (Shanghai) Pilot Free Trade Zone
Postal Code: 200131
Tel +86 21 6858 8699

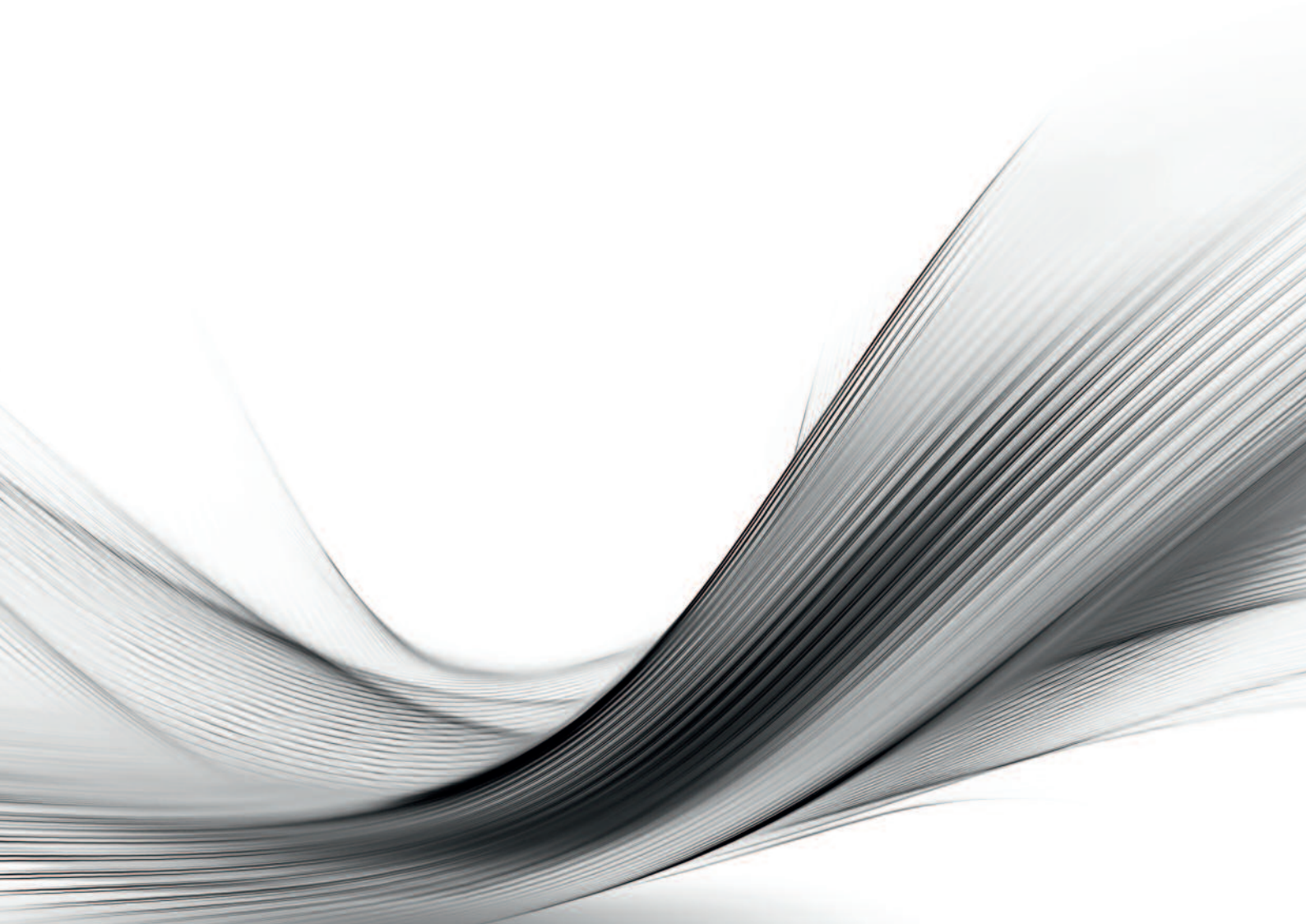

BRUNTON SHAW

Sandy Lane, Worksop, S80 3ES, UK

Tel +44 (0)1909 537 600

sales@brunton-shaw.co.uk

www.brunton-shaw.co.uk