



HIGH-PERFORMANCE

**MINING  
ROPE**







## OUR WORLD

Usha Martin is one of the largest manufacturers of wire ropes in the world. Our journey of more than six decades has been focused on manufacturing excellence, product innovation, technology improvements and customer satisfaction, which has resulted in establishing Usha Martin mining ropes as one of the most preferred and trusted brands in the world.

Usha Martin manufactures the most advanced mining wire ropes to the highest international standards to ensure the utmost safety in critical operations. Our wire ropes are designed to perform in the harshest mining conditions in both surface and underground mines, helping our customers to reduce downtime, optimise service life, reduce maintenance costs and enhance operational efficiency. Wire rope constructions offered for the mining industry are specially designed to withstand heavy loads, external wear, bending and vibrational stress to which these ropes are subjected.

At Usha Martin, we offer the widest range of fully plasticated mining ropes, which are used worldwide for dragline and shovel applications. The plastic offers many advantages including cushioning the strands and preventing inter-strand contact, reducing wear and rifling on rope path sheaves and drums, and locks lubrication within the rope which improves rope life. Usha Martin wire ropes undergo rigorous testing procedures to ensure superior quality to fulfil the requirement of demanding operating conditions. No matter how critical your application is, Usha Martin's expertise in the design and manufacturing of mining rope is always there to offer one-stop wire rope solutions for all your mining needs.

Mining companies, renowned for their critical applications, extensively use our high-performance ropes worldwide. Our desire to excel is exhibited through our group dynamics by having manufacturing facilities in India, Thailand, Dubai & the United Kingdom, distribution centres spread across continents, a Global Design Centre in Italy and service centres in India, the Netherlands, Scotland, Singapore and Dubai. Our service-focused model has elevated Usha Martin from being a wire rope supplier to a mining solutions provider in collaboration with our customers.

# GLOBAL FOOTPRINT



**60+** YEARS OF LEADERSHIP



PRESENCE ACROSS

**75+**  
COUNTRIES



**06** MANUFACTURING FACILITIES



**02** R&D CENTRES



**300+**  
CHANNEL PARTNERS



# MANUFACTURING CAPABILITIES

Our state-of-the-art manufacturing facilities have the capability to produce wire ropes ranging between 2 mm to 160 mm in diameter and are available in various tensile grades, from 1370 to 2160 N/mm<sup>2</sup> tensile.

---

Plastication facility for manufacturing Plastic Valley Filled (PVF) ropes up to 140 mm diameter.

---

Our fully equipped rigging shop allows pressed terminations from 3 mm to 128 mm (Talurit/Flemish/Swage buttons) and wire rope socketing up to 165 mm.

---

Undergoing all kinds of destructive and non-destructive testing.

---

9000 kN rope breaking load testing machine.

---

All mining ropes undergo rigorous testing procedures to meet the technical specifications as per our customer demand for today's challenging working conditions.

---

Shovel ropes fitted with swaged buttons are tested in-house that ensures to withstand the required pulling strength.





**SUPPORTING  
SAFETY VALUES IN  
THE MINING INDUSTRY**

Reduce Operating Costs  
with Usha Martin Mining Rope

# MINESFORM PVF®

High Performance Ropes

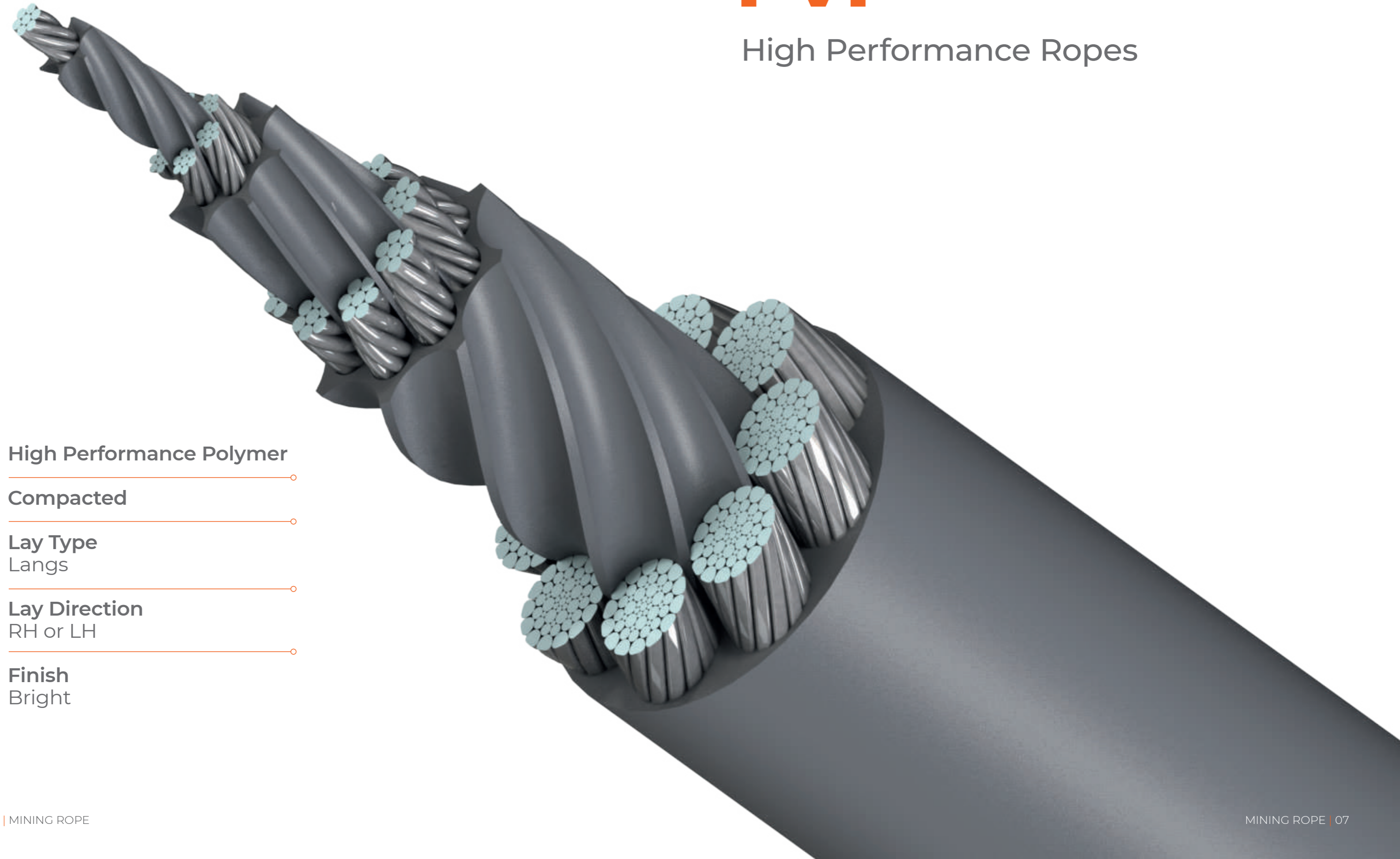

**High Performance Polymer**

**Compacted**

**Lay Type**

Langs

**Lay Direction**

RH or LH

**Finish**

Bright

# SURFACE MINING

Products	Shovel			Dragline			
	Hoist / Crowd Retract	Trip Rope	Boom Suspension	Hoist	Drag	Dump	Boom Suspension
Minesform® 6 / 6PVF	✓			✓	✓	✓	
Minesform® 8 / 8PVF	✓			✓		✓	
Spiral Strand			✓				✓
6 Strand PVF		✓					





# PRODUCT GUIDE FOR SURFACE MINING

## MINESFORM® 6 / 6PVF

Construction	Nominal Rope Diameter		Appprox. Mass		Minimum Breaking Strength	
	mm	Inch	kg/m	lb/ft	kN	MT
6x37SF	38	1½	6.35	4.27	955	97
	40		7.04	4.73	1058	108
		1⅝	7.50	5.04	1127	115
	42		7.76	5.21	1167	119
		1¾	8.52	5.73	1281	131
	46		9.31	6.26	1400	143
	48	1⅞	10.1	6.81	1524	155
	50		11.0	7.39	1654	169
		2	11.4	7.63	1707	174
	52		11.9	8.00	1789	182
	54	2⅛	12.8	8.62	1929	197
	56		13.8	9.27	2074	211
		2¼	14.4	9.66	2161	220
	58		14.8	9.95	2225	227
	60	2⅜	15.8	10.6	2381	243
	64	2½	17.5	11.7	2625	268
	66	2⅝	19.8	13.3	2969	303
	70	2¾	21.1	14.2	3241	330
6x50SF	73	2⅞	22.9	15.4	3472	354
	76	3	24.8	16.7	3760	383
		3⅛	27.1	18.2	4102	418
6x57SF	83	3¼	29.6	19.9	4421	451
	86	3⅜	31.4	21.1	4746	484
	89	3½	33.7	22.6	5083	518
	92	3⅝	36.0	24.2	5431	554
6x55SF	95	3¾	38.4	25.8	5698	581
		3⅞	41.2	27.7	6117	624
		4	43.9	29.5	6517	665

**Note:** Other Constructions, sizes & breaking load values not shown in the above table are also available on request.

# MINESFORM® 8 / 8PVF

Construction	Nominal Rope Diameter		Appox. Mass		Minimum Breaking Strength	
	mm	Inch	kg/m	lb/ft	kN	MT
8x37SF	38	1½	6.39	4.29	980	100
	40		7.04	4.73	1080	110
		1⅝	7.50	5.04	1150	117
	42		7.76	5.21	1191	121
		1¾	8.69	5.84	1334	136
	46		9.31	6.26	1428	146
	48	1⅞	10.1	6.81	1555	159
	50		11.0	7.39	1688	172
		2	11.4	7.63	1742	178
	52		11.9	8.00	1825	186
	54	2⅛	12.8	8.62	1968	201
	56		13.8	9.27	2117	216
	57	2¼	14.4	9.66	2205	225
	58		14.8	9.95	2271	232
		2⅜	16.0	10.8	2457	251
	62		16.9	11.4	2595	265
		2½	17.7	11.9	2722	278
64		18.0	12.1	2765	282	
8x50SF	66	2⅝	19.8	13.3	3030	309
	70	2¾	21.6	14.5	3308	337
	72		22.8	15.3	3499	357
	73	2⅞	23.5	15.8	3600	367
	76	3	25.6	17.2	3919	400
		3⅛	27.7	18.6	4253	434
	83	3¼	30.3	20.4	4650	474
	86	3⅜	32.5	21.9	4992	509
	89	3½	34.9	23.4	5347	545
	92	3⅝	37.2	25.0	5713	583
8x55SF	95	3¾	39.7	26.7	6092	621
		4	45.4	30.5	6710	711
	111	4⅜	54.2	36.4	8009	848
8x61		4½	57.5	38.6	8492	899
	127	5	71.0	47.7	10484	1110

Note: Other Constructions, sizes & breaking load values not shown in the above table are also available on request.

# ADVANTAGES OF MINESFORM® ROPES

## ADVANTAGES OF ROPE COMPACTION ON MINESFORM® 6 AND 8 STRAND ROPES.

Improves fatigue performance.

---

Reduces rope path wear.

---

Increases rope strength.

---

Greater resistance to abrasion.

---

Enhanced resistance to crushing.

## ADVANTAGES OF 6 STRAND ROPES

Larger outer wires improve abrasion and fatigue resistance.

---

Proven, robust construction for excellent wear resistance.

---

Established constructions for most dragline applications.

## ADVANTAGES OF PLASTIC FILLED ROPES

Plastic Impregnation cushions the strands and prevents inter strand contact.

---

Plastic Valley Filled (PVF) ropes reduce the impact of rock fall.

---

Plastication improves the life of the drum and sheaves.

---

PVF ropes keep the internal lubricant intact and keeps out dirt and dust.

---

The PVF ropes increase safety by providing a cleaner working environment. (External lubrication is not required which also reduces operating cost).

---

Improved operational productivity as ropes last longer, requiring less rope changes and thus reducing the downtime.

---

Suitable for Dragline & Shovel hoist Ropes applications.

## ADVANTAGES OF 8 STRAND ROPES

Increased flexibility.

---

Improved fatigue performance.

---

Reduced bending stresses.

---

Improved wear resistance.

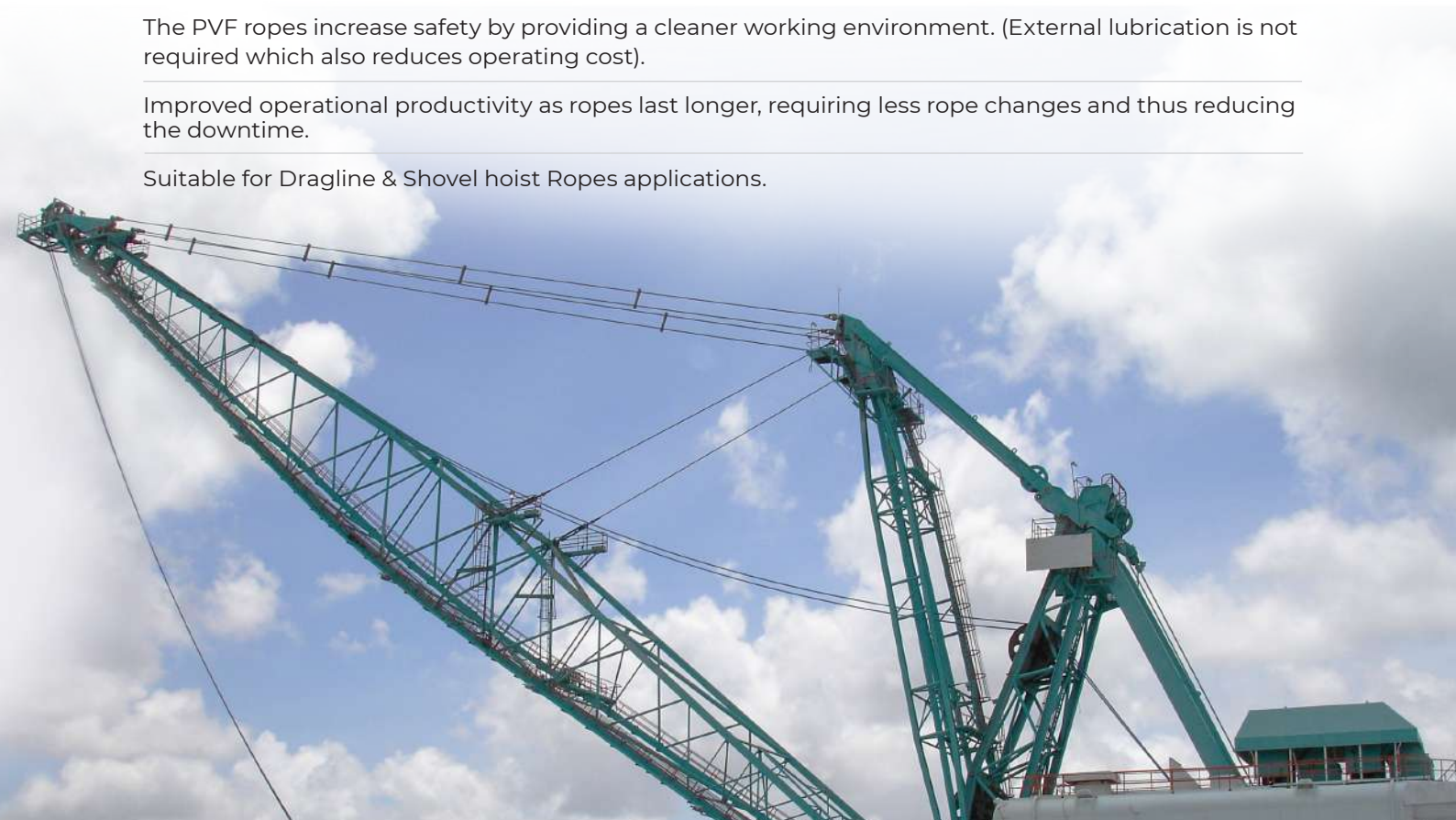

# MAXIMIZING ROPE LIFE IN SURFACE MINING

Wire ropes used on shovels and draglines ultimately wear out and must be replaced, despite their strength and longevity. Usha Martin in collaboration with its customers can assist in developing rope management strategies to maximise rope life.

## This can be achieved through:

Rope maintenance strategies.

---

Rope path audits in consultation with customers.

---

Product development.

---

Rope life predictability and information systems.

---

Mine maintenance and operator personnel training.

---

Rope inspections.

Rope inspections can assist customers by providing feedback on general rope condition including lubrication, broken wires, abrasive wear and mechanical damage.

When inspecting surface mining ropes and rope paths, special attention is needed at the critical work areas such as wedge sockets, rope pit contact area, sheaves and rollers, and drums.

## Rope End

In surface mining, dimension details of the rope end termination required at the time of ordering. For ease of installation, we can supply a full range of end fittings including bucket loops.

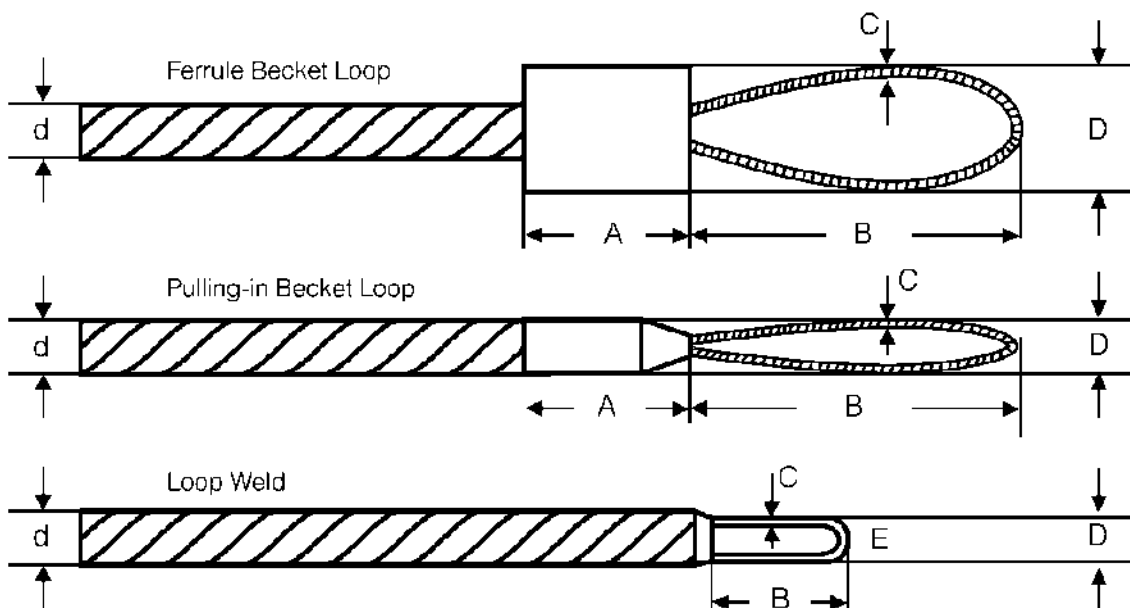

# SPIRAL STRAND BOOM PENDANT ROPE

Construction	Nominal Rope Diameter	Appox. Mass		Minimum Breaking Strength	
		mm	kg/m	lb/ft	kN
1x19	11	0.611	0.411	99.9	113
	13	0.853	0.573	140	157
1x37	14.5	1.06	0.712	174	196
	16	1.29	0.867	211	238
	19	1.82	1.22	298	336
	22	2.44	1.64	390	439
	26	3.41	2.29	544	614
	29	4.25	2.86	677	763
	32	5.17	3.47	824	930
1x61	35	6.19	4.16	986	
	32	5.17	3.47	823	928
	35	6.19	4.16	985	110
	38	7.29	4.90	160	1310
	42	8.91	5.99	1420	
1x91	45	10.2	6.87	1630	
	40	8.08	5.43	1280	1450
	42	8.91	5.99	1410	1590
	45	10.2	6.85	1620	1830
	48	11.6	7.79	1850	2080
	51	13.1	8.80	2090	2350
1 X 127 .....217	54	14.7	9.88	2340	2640
	57	16.4	11.0	2610	2940
	60	18.2	12.2	2890	3250
	64	20.7	13.9	3280	3700
	66	22.0	14.8	3490	3940
	68	23.4	15.7	3710	4180
	71	25.5	17.1	4040	4560
	74	27.7	18.6	4390	4950
	77	29.9	20.1	4750	5360
80	32.3	21.7	5130	5790	

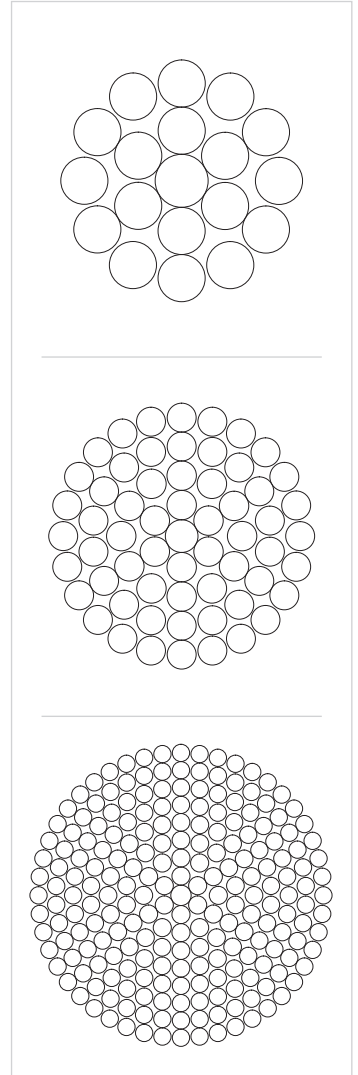

**Note:** Other Constructions, sizes & breaking load values not shown in the above table are also available on request.

# UNDER GROUND MINING

Products	Hoist Rope	Guide Rope	Balance Rope (Tail Rope)
MINESFORM 35	√		
MINESLOCK FL	√		
MINESFLEX 6FS	√		
MINESFLEX 6FSX	√		
MINESFLEX 34			√
MINESLOCK HLG		√	

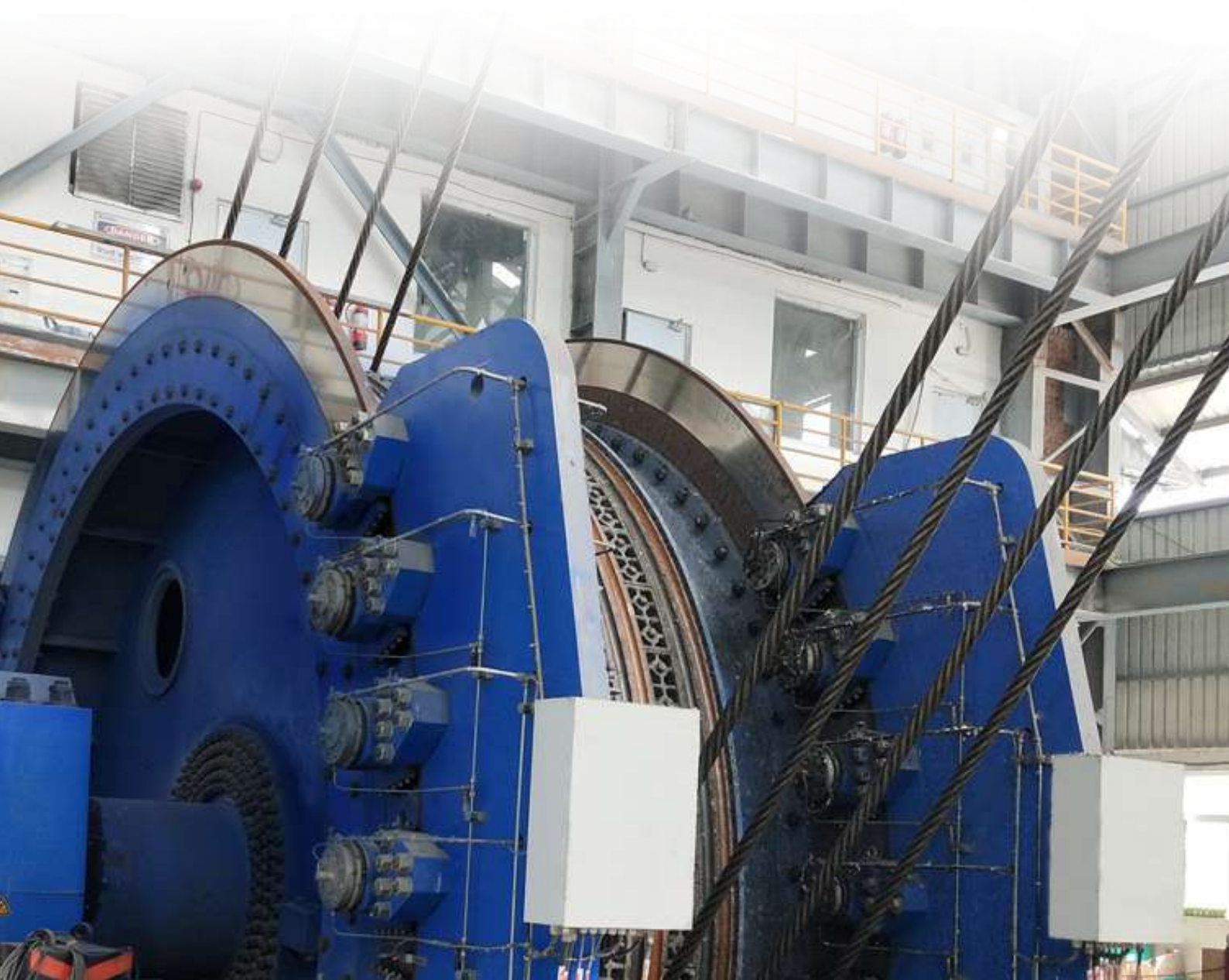

# PRODUCT GUIDE FOR UNDERGROUND MINING

## MINESFORM® 35 ROTATION RESISTANT ROPE

Nominal Rope Diameter		Appox. Mass		Minimum Breaking Strength			
				1770 Grade		1960 Grade	
mm	Inch	kg/m	lb/ft	kN	MT	kN	MT
22		2.43	1.63	400	40.7	444	45.3
	7/8	2.49	1.67	408	41.6	453	46.2
24		2.90	1.95	478	48.7	531	54.1
	1	3.25	2.18	532	54.2	591	60.2
26		3.40	2.28	559	57.0	621	63.3
28		3.94	2.65	648	66.1	720	73.4
	1 1/8	4.11	2.76	673	68.6	748	76.2
30		4.53	3.04	744	75.9	827	84.3
32	1 1/4	5.15	3.46	850	86.6	944	96.2
35	1 3/8	6.16	4.14	1008	102.8	1120	115
36		6.52	4.38	1071	109.2	1190	121
38	1 1/2	7.26	4.88	1197	122.1	1330	135
40		8.05	5.41	1305	133.1	1450	148
42		8.87	5.96	1341	136.7	1490	152
44		9.74	6.54	1458	148.7	1620	165
	1 3/4	9.94	6.68	1485	151.4	1650	168
46		10.6	7.12	1593	162.4	1770	180
48		11.6	7.79	1746	178.0	1940	197
50		12.6	8.47	1872	190.9	2080	212
	2	13.0	8.74	1935	197.3	2150	219
52		13.6	9.14	2034	207.4	2260	230
60		18.1	12.2	2709	276.2	3010	307
64		20.7	13.9	3078	313.9	3420	349
66		22.1	14.9	3276	334.1	3640	371

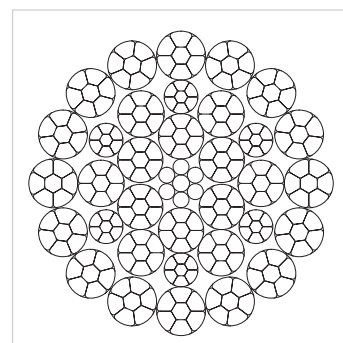

# MINESLOCK FL

## FULL LOCKED COIL WINDING ROPE

Nominal Rope Diameter	Appox. Mass		Minimum Breaking Strength
			1570 Grade
mm	kg/m	lb/ft	kN
16	1.48	0.995	208
18	1.88	1.26	264
19	2.09	1.40	294
20	2.32	1.56	326
21	2.56	1.72	359
22	2.81	1.89	394
24	3.34	2.24	469
25	3.63	2.44	509
26	3.92	2.63	550
27	4.23	2.84	593
28	4.47	3.00	638
29	4.79	3.22	685
30	5.13	3.45	733
32	5.84	3.92	834
34	6.59	4.43	941
35	6.98	4.69	997
36	7.39	4.97	1055
37	7.80	5.24	1114
38	8.23	5.53	1176
39	8.67	5.83	1238
40	9.12	6.13	1303
42	10.1	6.75	1436
44	11.0	7.42	1576
46	12.1	8.10	1723
48	13.1	8.82	1876
51	14.8	9.97	2117
54	16.6	11.2	2374
57	18.5	12.4	2645
60	20.5	13.8	2931

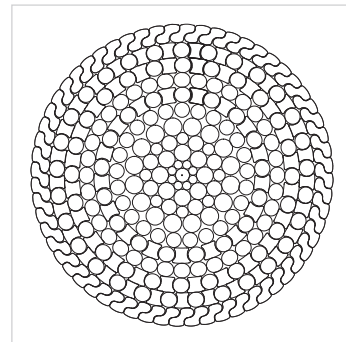



## MINESFLEX 6FS FLATTENED STRAND

Nominal Rope Diameter	Appox. Mass		Minimum Breaking Strength		
			1420 Grade	1570 Grade	1770 Grade
mm	kg/m	lb/ft	kN	kN	kN
25	2.56	1.72	321	355	400
26	2.77	1.86	347	384	433
28	3.21	2.16	403	446	502
29	3.45	2.32	432	478	539
32	4.20	2.82	526	582	656
33	4.46	3.00	560	619	698
35	5.02	3.37	630	696	785

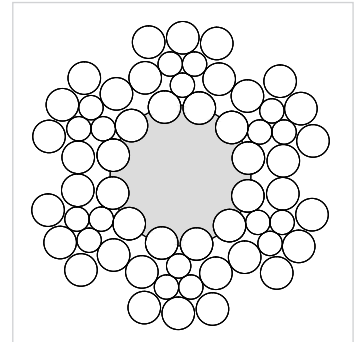

## MINESFLEX 6FSX TRIANGULAR STRAND

Nominal Rope Diameter	Appox. Mass		Minimum Breaking Strength		
			1420 Grade	1570 Grade	1770 Grade
mm	kg/m	lb/ft	kN	kN	kN
24	2.36	1.59	287	317	358
25	2.56	1.72	312	344	388
26	2.77	1.86	337	373	420
28	3.21	2.16	391	432	487
29	3.45	2.32	419	463	522
32	4.20	2.82	510	564	636
33	4.46	3.00	543	600	677
35	5.02	3.37	611	675	761
36	5.31	3.57	646	714	805
37	5.61	3.77	682	754	851
38	5.92	3.98	720	796	897
40	6.56	4.41	797	882	994
44	7.94	5.34	965	1067	1203

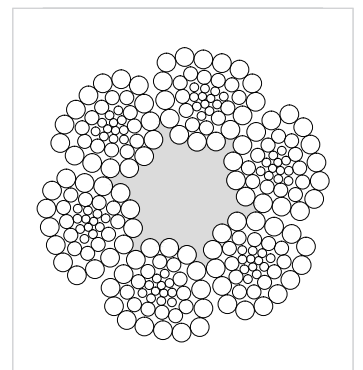

Note: We can also supply ropes with steel core.

# MINESFLEX 34 BALANCE ROPE

Nominal Rope Diameter	Appox. Mass		Minimum Breaking Strength		
			1570 Grade	1770 Grade	1960 Grade
mm	kg/m	lb/ft	kN	kN	kN
24	2.45	1.65	283	318	353
26	2.87	1.93	332	374	414
28	3.33	2.24	385	433	480
30	3.83	2.57	442	497	551
32	4.35	2.92	503	566	627
34	4.91	3.30	568	639	708
36	5.51	3.70	636	716	794
38	6.14	4.13	709	798	884
40	6.80	4.57	786	884	980
42	7.50	5.04	866	975	1080
44	8.23	5.53	951	1070	1186
46	8.99	6.04	1039	1170	1296
48	9.79	6.58	1131	1273	1411
50	10.6	7.14	1228	1382	1531
52	11.5	7.72	1328	1495	1656
54	12.4	8.33	1432	1612	1786
56	13.3	8.96	1540	1733	1920
58	14.3	9.61	1652	1859	2060
60	15.3	10.3	1768	1990	2205

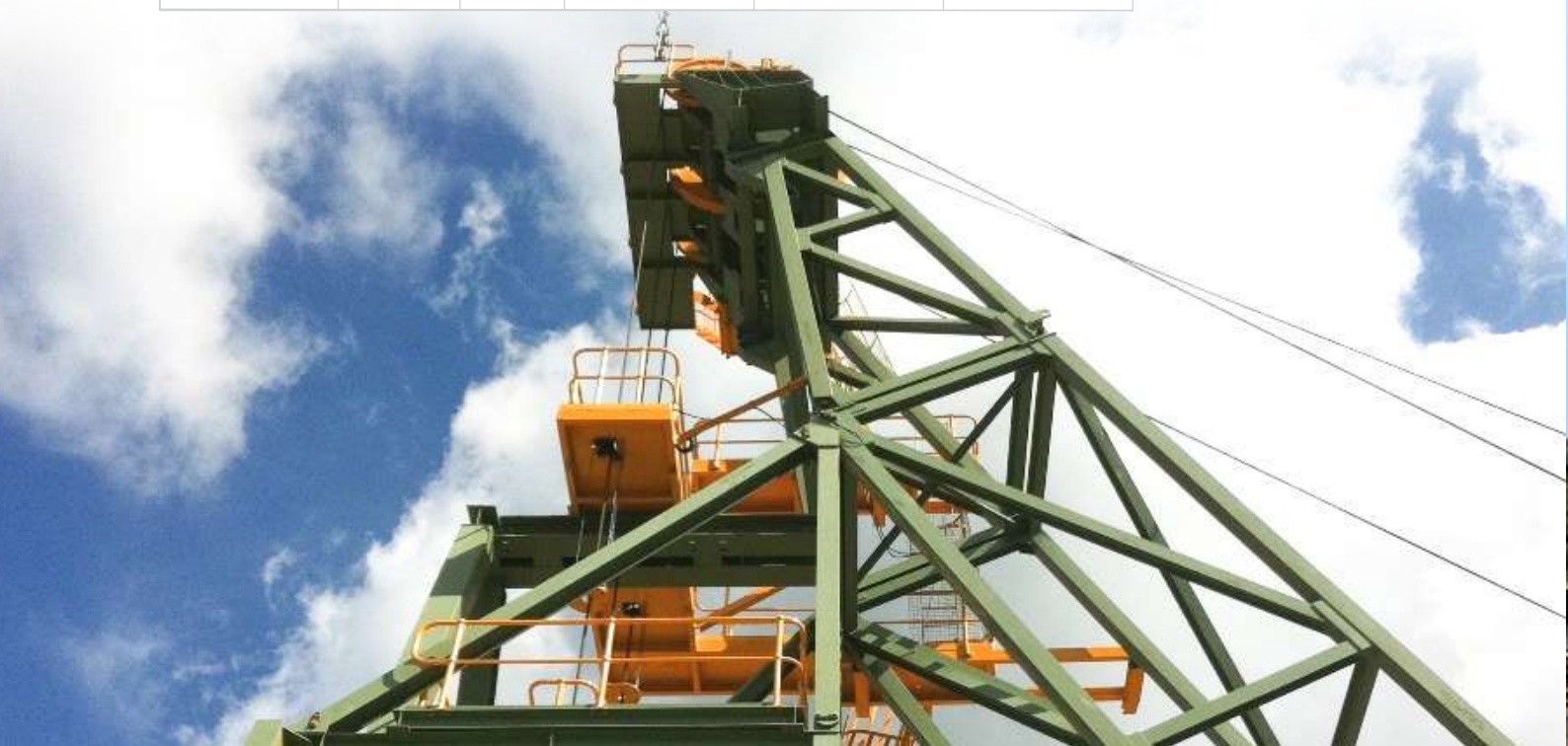
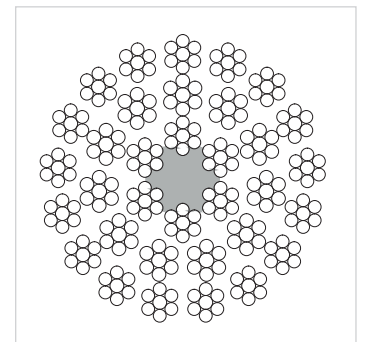

# MINESLOCK HLG HALF LOCKED GUIDE ROPE

Nominal Rope Diameter	Appox. Mass		Minimum Breaking Strength	
			700-900N /mm <sup>2</sup>	800-950N /mm <sup>2</sup>
mm	kg/m	lb/ft	kN	kN
29	4.56	3.06	319	386
32	5.58	3.75	387	473
35	7.11	4.78	473	580
38	8.40	5.64	560	686
41	9.77	6.57	666	811
44	11.3	7.56	772	937
48	13.4	9.00	879	1081
50	14.5	9.76	1004	1229
54	17.0	11.4	1159	1419

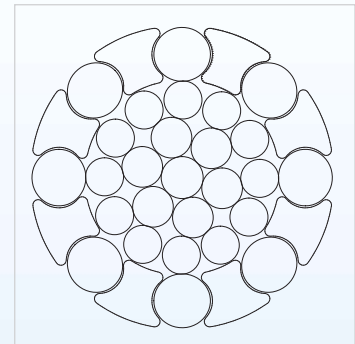

# CARE DURING UNLOADING, STORAGE, CUTTING, INSTALLATION & SERVING OF LOCKED COIL WIRE ROPE.

Locked coil wire ropes are smooth surface strands composed of shaped wires and/or a combination of shaped and round wires laid in concentric layers around a centre of round wires. These ropes are specially designed high strength wire rope as compared to ordinary stranded ropes and far more care is essential for their handling, maintenance & inspection, both during storage as well as service.

## A. The important precautions during Unloading & Storage

1. All packing should be taken off on receipt of any rope in store and the rope should be thoroughly checked for any possible physical damage in transit or delivery.

---

2. Special care should be taken for handling of Reels at the delivery time. Suitable tackle and lifting arrangement should be made available to avoid any damage to the rope. If desired, by the customer, we can provide sling with each reel for this purpose.

---

3. Storage platform should be either cemented floor or seasoned wooden blocks to prevent the ropes from exposure to moisture which might cause rusting/ corrosion of ropes. Storage area should be covered suitably to avoid atmospheric exposure and its location should not be where the ropes are liable to be affected by acid fumes, steam or other corrosive elements.

---

4. Once in every three months the reel containing wire rope should be rolled by 180° to prevent draining out of the lubricant from the lower layers of the rope.

## B. The important precautions during Cutting

1. Prior to rope cutting, it should be served with soft annealed serving wire for a length at least 14 times the rope diameter at minimum 5 places from cutting end at approx. 1 meter intervals. These servings should be applied with a serving mallet and these servings must be soldered over their full length.

At least 6 nos. of rope clamps should be put cross-wise position at the intermediate positions of the above servings. Two more clamps should be fixed adjacent to cutting mark. The distance between these two clamps at the cutting point should be kept at bare minimum. These measures ensure that the outer layers containing shaped wires do not slacken on the core, which if allowed to occur will disturb the balanced condition of the rope resulting in permanent distortion of the outer cover and ruin the full or considerable length of the rope.

2. These Ropes should be cut using high speed abrasive cutter.

### C. The important precautions during Installations

1. The top end of the rope should go to the winding drum for attaching it to the drum directly.
2. The rope should be smoothly paid off from the reel mounted on a stand and supported by a shaft. It is essential to have proper braking mechanism to the reel to maintain constant tension during paying off. A wooden plank acting as lever against reel flange is a simple means of braking, but it is not always satisfactory. The constant tension during paying off operation will prevent over run leading to a possible kink.

### D. Other important points

1. Before installation of new rope check the sheave groove by taking a Plaster of Paris mould & drawing the profile, the sheave groove diameter should be Maximum Rope Dia, +7.5% & Minimum Rope diameter +3%. If it is not within the tolerance mentioned above, the groove should be machined properly, if required, before installation of new rope.
2. Every pulley or sheave used in connection with winding shaft, while in motion should rotate in vertical plane without any wobbling effect.

### RECAPPING PROCEDURE

1. Mark the cutting position on the rope and place on clamp on each side of this point approx. 1" (25mm) apart.

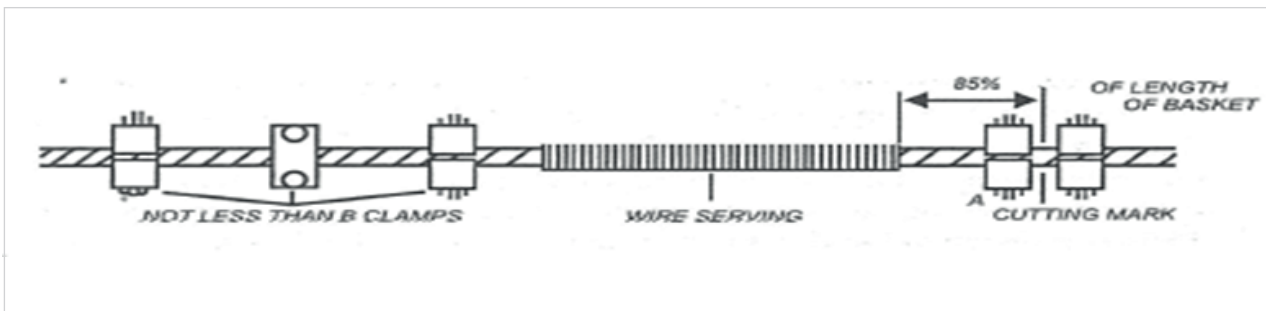

2. Straighten the rope and use serving wire to serve the rope tightly by a mallet. Commence serving the rope from a distance of 85% of the length of the capel basket away from the cutting point. The length of the serving should not be less than 60 cm. Soldering of full length serving is essential.
3. Place 6 tightly fitting clamps on the rope 1 meter apart commencing from the back of the serving. In between the clamps, 2 more soldered serving should also be provided, the rope may now be cut by abrasive rope cutter. Never use chisel and hammer.
4. Place the capel against the end clamp 'A' on the main body of the rope and slowly slacken this clamps until it can be slid backwards along the rope, allowing the Capel to pass over the rope.

5. Remove clamp 'A' and pass the Capel back over the serving until the outer end of the capel as at least 75mm behind the outer end of the serving.

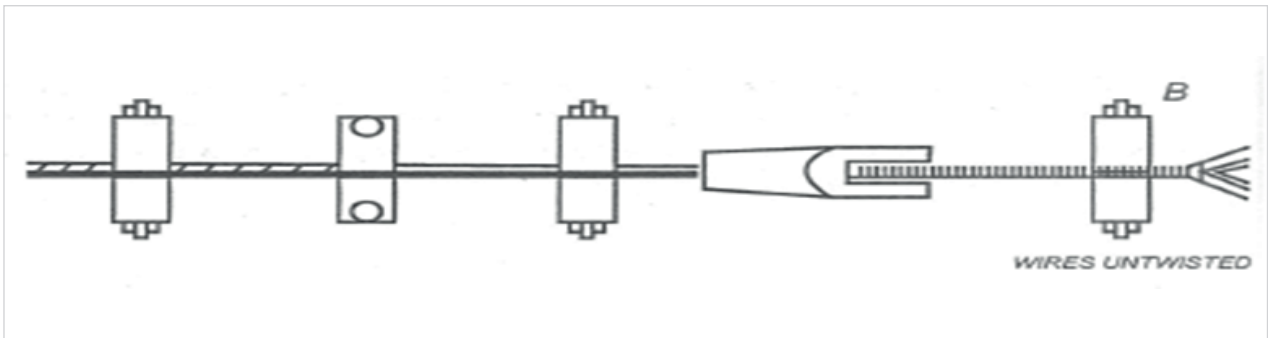

6. Place a special clamp 'B' at the end of the serving (clamp is bored to fit over serving). Open out the wires to form a brush and clean thoroughly with Trichloroethylene (TCE) or other suitable degreasing solvent. Petrol or paraffin is not recommended.

#### Special care while opening wires

- a. Do not bend the wire ends sharply.

- b. When cleaning with solvent, do this by inverting brush into solvent. Do not pour down the solvent into brush. It is essential that the brush (broom) is held downwards in the vertical position to prevent the degreasing fluid or solvent being percolating back into the wire rope which if allowed might contaminate the original manufacturing lubricant.

7. Remove clamp 'B' and draw the capel forward until the ends of the wires in the brush are level with the top of the capel basket.

8. Suspend/ fix the capel upright in such a position that allows the rope below the capel to remain straight and vertical for at least 36 times Rope Diameter.

9. Maintain the alignment of the rope and capel axis. Seal the gap between the rope and capel with white putty/ clay followed by clamp.

10. Heat the capel by means of external flame until the internal temperature of the capel is approx. 100°C. Whilst this procedure is being carried out the capping metal should be heated to the required temperature (360°C for white metal as per C.M. Regulation), pour the metal continuously until the basket is full.

11. Allow the metal to solidify and cool naturally.

12. When the capel is cold, remove the clamps, also remove approx. 15 cm of serving from the mouth of the capel, however, leave the remainder of the serving on the rope.

The above instructions must be carefully adhered to. Failure to put the requisite number of clamps before cutting or to retain clamps until the rope is securely held in the capel might result in the outer wires slipping upon the core and thereby destroying the balanced geometry of the Locked Coil Wire Rope.

## Key Guidance for LCWR Maintenance

### Daily:

Cleaning of winding rope by dry sack or cotton waste, along with drum grooves.

---

### Weekly:

Cleaning and checking of capel ends.

Cleaning and lubricating winding ropes (if special lubricant which add to the friction is available).

---

### Monthly:

Thorough inspection of all the ropes and measuring and recording actual diameter, wear, rust / corrosion, any visual abnormality on the rope surface at different location when the cage / skip is at various levels.

---

### Half yearly:

Harmonic test / collar to collar check.

Groove diameter measurement.

Measurement of rope elongation.

Non-destructive test.

---

**Avoid running the ropes with unequal tension.**

## Lubrication

Special care should be given to the lubrication. Only lubricant recommended by the manufacturer should be used.

Particular attention and effective control should be given to areas of the rope and attachments where additional corrosion is expected. These areas include, but are not limited to:

- a) Areas, including the rope and attachments, susceptible to the gravitational effects of moisture and water.

---

- b) Static areas of the rope that are untested and often not monitored via the regular maintenance inspections.

---

- c) Areas of the rope and attachments that are often difficult to access.

Guide and tail ropes should be regularly lubricated. The type of lubricant should be investigated and the results of the life and wear conditions of the rope, environmental conditions etc. should be recorded for ongoing improvement.

Particular attention should be paid to excess lubricant around brake paths and local environment where excess rope lubricant or grease may present additional risk.

There are some special purpose lubricants for friction winder head ropes. These should not have regular grades of rope lubricant applied because of the reduction of friction around the drum and subsequent potential rope slip. Other ropes should be regularly lubricated to extend their life. Lubrication will limit both internal and external corrosion and wear and maintain higher rope strength

# MAN & MATERIAL TRANSPORTATION

Products	Track Rope	Aerial Haulage	Cable belt conveyor
MINESLOCK FLT	√		
6x19S/ 6x17S/ 6x26WS/ 6xK19S/ 6xK17S/ 6xK26WS		√	√





# PRODUCT GUIDE FOR MAN AND MATERIAL TRANSPORTATION

## 6X19S AERIAL HAULAGE/ CABLE BELT CONVEYOR

Nominal Rope Diameter	Approx. Mass		Minimum Breaking Strength		
			1570 Grade	1770 Grade	1960 Grade
mm	kg/m	lb/ft	kN	kN	kN
12	0.537	0.361	75.0	84.0	93.0
13	0.630	0.423	88.0	99.0	110
14	0.730	0.491	102	115	127
16	0.954	0.641	133	150	166
18	1.21	0.813	168	190	210
19	1.35	0.907	188	211	234
20	1.49	1.00	208	234	260
22	1.80	1.21	252	284	314
24	2.15	1.44	299	337	374
25	2.33	1.57	325	366	406
26	2.52	1.69	351	396	439
28	2.92	1.96	407	459	509
30	3.35	2.25	468	527	584
32	3.82	2.57	532	600	664
34	4.31	2.90	600	677	750
36	4.83	3.25	673	759	841
38	5.38	3.62	750	846	937
40	5.96	4.00	831	937	1038
42	6.57	4.41	917	1033	1144
44	7.21	4.84	1006	1134	1256
46	7.88	5.30	1099	1240	1373
48	8.58	5.77	1197	1350	1495
50	9.32	6.26	1299	1465	1622
51	9.70	6.52	1351	1524	1688

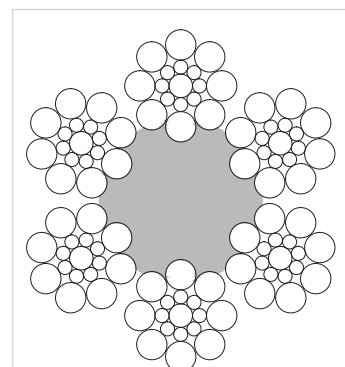

# MINESLOCK FLT FULL LOCKED COIL TRACK ROPE

Nominal Rope Diameter	Appox. Mass		Minimum Breaking Strength		
			1370 Grade	1470 Grade	1570 Grade
mm	kg/m	lb/ft	kN	kN	kN
25	3.50	2.35	520	558	596
26	3.79	2.55	562	603	644
28	4.40	2.96	652	700	747
29	4.72	3.17	699	750	801
30	5.05	3.39	748	803	858
32	5.74	3.86	851	914	976
34	6.48	4.35	961	1030	1100
35	6.87	4.62	1020	1090	1170
36	7.27	4.89	1080	1160	1230
37	7.68	5.16	1140	1220	1300
38	8.10	5.44	1200	1290	1380
39	8.53	5.73	1260	1360	1450
40	8.97	6.03	1330	1430	1520
42	9.89	6.65	1470	1570	1680
43	10.4	6.99	1540	1650	1760
44	10.9	7.32	1610	1730	1840
45	11.4	7.66	1680	1810	1930
46	11.9	8.00	1760	1890	2020
48	12.9	8.67	1920	2060	2200
50	14.0	9.41	2080	2230	2380
52	15.2	10.2	2250	2410	2580
54	16.4	11.0	2420	2600	2780
55	17.0	11.4	2520	2700	2880
56	17.6	11.8	2610	2800	2990
58	18.9	12.7	2800	3000	3210
60	20.2	13.6	2990	3210	3430
61	21.9	14.7	3240	3480	3710
62	22.6	15.2	3350	3590	3840
64	24.1	16.2	3570	3830	4090
65	24.8	16.7	3680	3950	4220
66	25.6	17.2	3790	4070	4350
68	27.2	18.3	4030	4320	4620
69	28.0	18.8	4150	4450	4750

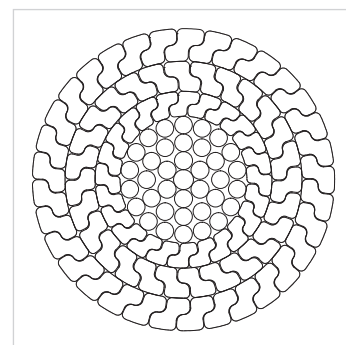

# MINESLOCK FLT

## FULL LOCKED COIL TRACK ROPE

Nominal Rope Diameter	Appox. Mass		Minimum Breaking Strength		
			1370 Grade	1470 Grade	1570 Grade
mm	kg/m	lb/ft	kN	kN	kN
70	28.8	19.4	4270	4580	4890
72	30.5	20.5	4520	4850	5180
74	32.2	21.6	4770	5120	5470
75	33.0	22.2	4900	5260	5620
76	33.9	22.8	5030	5400	5770
77	34.8	23.4	5160	5540	5920
78	35.7	24.0	5300	5690	6070
79	36.7	24.7	5440	5830	6230
80	37.6	25.3	5580	5980	6390
82	39.5	26.5	5860	6290	6710
84	41.5	27.9	6150	6600	7040
86	43.4	29.2	6440	6910	7380
88	45.5	30.6	6750	7240	7730
89	46.5	31.2	6900	7400	7910
90	47.6	32.0	7060	7570	8090



### METRIC - IMPERIAL DIAMETER CONVERSION

in.	mm.	in.	mm	in.	mm.	in.	mm.	in.	mm	in.	mm.
5/32	3.97	1/2	12.7	15/16	23.8	1 1/2	38.1	2 1/2	63.5	4 1/4	108.0
3/16	4.76	9/16	14.3	1	25.4	1 5/16	41.3	2 3/4	69.9	4 1/2	114.3
7/32	5.56	5/8	15.9	1 1/16	27.0	1 3/4	44.5	3	76.2	4 3/4	120.7
1/4	6.35	11/16	17.5	1 1/8	28.6	1 7/8	47.6	3 1/4	82.6	5	127.0
5/16	7.94	3/4	19.0	1 3/16	30.2	2	50.8	3 1/2	88.9		
3/8	9.53	13/16	20.6	1 1/4	31.8	2 1/8	54.0	3 3/4	95.3		
7/16	11.1	7/8	22.2	1 3/8	34.9	2 1/4	57.2	4	101.6		

### CONVERSION TABLE

Length	1m	=1000mm	=3,28ft	=39,37inch
Force	1kN	=101,97kp	=0,10197 t metric-f	=224lbs-f
Tensile strength	1N/mm <sup>2</sup>	=0,10197 kp/mm <sup>2</sup>	=145,04 p.s.i.	=10 bar
Cross Section	1mm <sup>2</sup>	=0,00155 sq.inch		
Weight	1 metric t	=1000 kg = 1,102 short t	=0,9842 long t	=2204,6 lbs
Weight per Length Unit	1kg/m	=0,672 lbs/ft		

## SAFETY INFORMATION

Any performance specifications are conditional on proper rope diameter, construction & grade of rope tensile; on proper design & maintenance of mechanical equipment on which the wire rope is used and on proper storage, handling, maintenance and periodic inspection of such products during the period of use.

Inspect wire rope and consult industry and equipment manufacturer recommendations before each use. The UML wire rope may not perform as expected if it is damaged, abused, overused or improperly maintained.

### DISCLAIMER

All statements, technical information and recommendations contained herein are believed to be reliable, but no guarantee is given as to their accuracy and/or completeness. The user must determine the suitability of the product for his own particular purpose, either alone or in combination with other products and shall assume all risk and liability in connection therewith.

Whilst every attempt has been made to ensure accuracy in the content of the tables, the information contained in this catalogue does not form any part of a contract.



## CORPORATE OFFICE

### USHA MARTIN LIMITED

2A, Shakespeare Sarani 'Mangal Kalash'  
Kolkata – 700 071  
Phone: +91 33 71006300 / +91 33 71006492  
Fax: +91-33-71006400  
Email: contact@ushamartin.co.in

## DOMESTIC OFFICES

### NORTH REGIONAL OFFICE

#### USHA MARTIN LIMITED

701, 'Surya Kiran' 19,  
Kasturba Gandhi Marg,  
New Delhi – 110 001  
Phone: +91 11 2331 5156  
Email: marketing-north@ushamartin.co.in

### EAST REGIONAL OFFICE

#### USHA MARTIN LIMITED

2A, Shakespeare Sarani 'Mangal Kalash'  
Kolkata – 700071  
Phone: +91 33 71006492  
Email: marketing-east@ushamartin.co.in

### SOUTH REGIONAL OFFICE

#### USHA MARTIN LIMITED

lot No. L9 (1), Phase-II, Sipcot Industrial Park,  
Sriperumbudur, Kancheepuram - 602 105,  
Chennai, Tamilnadu  
Phone: +91 44 3717 5100  
Email: marketing-south@ushamartin.co.in

### WEST REGIONAL OFFICE

#### USHA MARTIN LIMITED

Office No.1001/1002, Chandak Chambers,  
Near WEH Metro Station, Andheri Kurla Road,  
Andheri (E), Mumbai – 400 069  
Phone: +91 22 6239 0290  
Email: marketing-west@ushamartin.co.in

## OVERSEAS OFFICES

### USHA MARTIN AMERICAS, INC

701 Plastics Avenue,  
Houston Texas 77020, USA  
Phone: +171 3676 1800  
Email: sales@ushamartinus.com

### USHA MARTIN UK LIMITED

Tasman House,  
Mariner Court Clydebank, Glasgow,  
G81 2NR, UK  
Phone: + 44 141 951 8801  
Email: info@ushamartin.co.uk

### EMM CORP

Howe Moss Place,  
Kirkhill Industrial Estate Dyce,  
Aberdeen AB 21 OGS, Scotland, U.K  
Phone: +44 1224 77 5151  
Email: info@emmcop.com

### BRUNTON SHAW UK

Sandy Lane, Worksop, S80 3ES, UK  
Phone: + 44 1909 537 600  
Email: info@brunton-shaw.co.uk

### DE RUITER STAALKABEL B.V.

Kerkeplaat 10, 3313 LC Dordrecht  
The Netherlands  
Phone: +31 (0) 78 – 8200600  
Email: info@drstk.nl

### USHA MARTIN EUROPE B.V.

Kerkeplaat 10  
3313 LC Dordrecht The Netherlands  
Phone: +31 (0) 180 – 745099  
Email: info@ushamartineurope.com

### BRUNTON WIRE ROPES FZCo.

P.O. Box 17491, M00301  
Jebel Ali Free Zone, Dubai U.A.E  
Phone: + 971 50 4503717  
Email: sm@bsme-uae.com

### USHA SIAM STEEL INDUSTRIES PUBLIC COMPANY LIMITED

66 Q House Asoke Building,  
12th Floor, Unit 1207 Sukhumvit 21 road,  
North Klongtoey, Wattana, Bangkok 10110  
Phone: +662 261 7361- 4  
E-mail: info@ushasiam.com

### USHA MARTIN SINGAPORE PTE LIMITED

91 Tuas Bay Drive, Usha Martin Building,  
Singapore – 637307  
Phone: +65 6265 7756  
Email: sales@umsingapore.com

### USHA MARTIN AUSTRALIA PTY LTD

Sydney Office: 199, Hassall Street,  
Wetheril Park, NSW 2164  
Phone: +61 411 095 983  
Perth Office: 31 Colin Jamieson Drive,  
Welshpool WA 6106 Phone: +61 419 939 567  
Email: marketing-australia@ushamartin.co.in

### USHA MARTIN VIETNAM CO. LTD

18A, D2 Street, Ward 25,  
Binh Thanh District, Ho Chi Minh City,  
S.R Vietnam  
Phone: +84 28 3512 2209  
Email: qui@umvietnam.com.vn

### PT. USHA MARTIN INDONESIA

Konica Building 3A Floor Jl.  
Gunung Sahari Raya 78 Jakarta 10610,  
Indonesia  
Phone: +62 21 42870794  
Email: marketing-indonesia@ushamartin.co.in

### USHA MARTIN ITALIA S.R.L

Via Antonio Segni 6  
25062 Concesio (BS), Italy.  
Phone: +39 030 7741330  
Email: info@ushamartin.it

### USHA MARTIN CHINA CO. LTD.

Area D, Block 1, No 461 Huajing Road China  
(Shanghai) Pilot Free Trade Zone,  
Shanghai, China Postal code: 200131  
Phone: +65 6265 7756  
Email: yhw@umchina.com.cn

Follow us on:



www.ushamartin.com